

Dell™ Dimension™ 2200

# Owner's Manual



# Hints, Notices, and Cautions



**HINT:** A HINT indicates important information that helps you make better use of your computer.



**NOTICE:** A NOTICE indicates either potential damage to hardware or loss of data and tells you how to avoid the problem.



**CAUTION:** A CAUTION indicates a potential for property damage, personal injury, or death.

# Abbreviations and Acronyms

For a complete list of abbreviations and acronyms, see the *Tell Me How* help file. To access help files, see page 26.

---

**Information in this document is subject to change without notice.  
© 2002 Dell Computer Corporation. All rights reserved.**

Reproduction in any manner whatsoever without the written permission of Dell Computer Corporation is strictly forbidden.

Trademarks used in this text: *Dell*, the *DELL* logo, *Dimension*, *Inspiron*, *Latitude*, *OptiPlex*, *Dell Precision*, and *DellNet* are trademarks of Dell Computer Corporation; *Intel* and *Celeron* are registered trademarks of Intel Corporation; *Microsoft* and *Windows* are registered trademarks of Microsoft Corporation.

Other trademarks and trade names may be used in this document to refer to either the entities claiming the marks and names or their products. Dell Computer Corporation disclaims any proprietary interest in trademarks and trade names other than its own.

This product incorporates copyright protection technology that is protected by method claims of certain U.S. patents and other intellectual property rights owned by Macrovision Corporation and other rights owners. Use of this copyright protection technology must be authorized by Macrovision Corporation, and is intended for home and other limited viewing uses only unless otherwise authorized by Macrovision Corporation. Reverse engineering or disassembly is prohibited.

# Contents

<b>Safety Instructions</b> . . . . .	<b>9</b>
When Using Your Computer . . . . .	9
When Working Inside Your Computer . . . . .	11
Protecting Against Electrostatic Discharge . . . . .	13
Ergonomic Computing Habits . . . . .	13
Battery Disposal . . . . .	14

## 1 Setting Up

<b>Connecting a Printer</b> . . . . .	<b>16</b>
Parallel Printer . . . . .	16
USB Printer . . . . .	17
Installing the Printer Driver . . . . .	18
<b>Transferring Information to a New Computer (Windows XP Only)</b> . . . . .	<b>19</b>
<b>Setting Up a Home and Office Network (Windows XP Only)</b> . . . . .	<b>20</b>
<b>Turning Off the Computer</b> . . . . .	<b>20</b>
Windows XP . . . . .	20
Windows 2000 . . . . .	20

## 2 Solving Problems

<b>Finding Solutions</b> . . . . .	<b>24</b>
<b>Accessing Help Files</b> . . . . .	<b>26</b>
<b>Power Problems</b> . . . . .	<b>26</b>
<b>Start-Up Error Messages</b> . . . . .	<b>27</b>

<b>Video and Monitor Problems</b> . . . . .	<b>28</b>
If the screen is blank . . . . .	28
If the screen is difficult to read . . . . .	29
<b>Sound and Speaker Problems</b> . . . . .	<b>30</b>
No sound from speakers . . . . .	30
No sound from headphones . . . . .	31
<b>Printer Problems</b> . . . . .	<b>32</b>
If you cannot print to a parallel port printer . . . . .	32
If you cannot print to a USB printer . . . . .	33
<b>Scanner Problems</b> . . . . .	<b>34</b>
<b>Modem Problems</b> . . . . .	<b>34</b>
<b>Mouse Problems</b> . . . . .	<b>36</b>
<b>Keyboard Problems</b> . . . . .	<b>37</b>
<b>Drive Problems</b> . . . . .	<b>37</b>
If you cannot save a file to a floppy disk . . . . .	37
If you cannot play a music CD or install a program from a CD . . . . .	38
If you cannot play a DVD movie . . . . .	39
If the CD-RW drive stops writing . . . . .	39
If you have a hard drive problem . . . . .	40
<b>Network Problems</b> . . . . .	<b>40</b>
<b>Microsoft® Windows® Error Messages</b> . . . . .	<b>41</b>
<b>General Program Problems</b> . . . . .	<b>42</b>
A program crashes . . . . .	42
A program stops responding . . . . .	42
A program error causes the system to lock up . . . . .	42
A solid blue screen appears . . . . .	42
A program is designed for an earlier Windows operating system . . . . .	43

<b>Internet Connection Problems</b> . . . . .	<b>43</b>
If you have a problem with your Internet connection . . . . .	43
<b>E-Mail Problems</b> . . . . .	<b>44</b>
<b>Resolving Other Technical Problems</b> . . . . .	<b>45</b>
<b>Reinstalling Drivers</b> . . . . .	<b>45</b>
Using the Windows XP Device Driver Rollback . . . . .	46
<b>Resolving Software and Hardware Incompatibilities</b> . . . . .	<b>47</b>
Windows XP . . . . .	47
Windows 2000 . . . . .	48
<b>Using System Restore</b> . . . . .	<b>49</b>
Creating a Restore Point . . . . .	50
Restoring the Computer to an Earlier Operating State . . . . .	51
Undoing the Last System Restore . . . . .	52
<b>Reinstalling Windows XP</b> . . . . .	<b>52</b>
<b>Reinstalling Windows 2000</b> . . . . .	<b>54</b>

### 3 Adding Parts

<b>Front and Back View of the Computer</b> . . . . .	<b>58</b>
<b>Removing the Computer Cover</b> . . . . .	<b>60</b>
<b>Rotating the Power Supply</b> . . . . .	<b>62</b>
<b>Looking Inside Your Computer</b> . . . . .	<b>65</b>
System Board . . . . .	66
<b>Adding a 3.5-Inch Drive</b> . . . . .	<b>67</b>
<b>Adding Cards</b> . . . . .	<b>73</b>
Removing Cards . . . . .	77

<b>Adding Memory</b> . . . . .	<b>78</b>
<b>Replacing the Computer Cover</b> . . . . .	<b>80</b>

## 4 Appendix

<b>Specifications</b> . . . . .	<b>82</b>
<b>Standard Settings</b> . . . . .	<b>86</b>
Viewing Settings . . . . .	87
System Setup Program Screens . . . . .	87
<b>Clearing Forgotten Passwords</b> . . . . .	<b>88</b>
<b>Replacing the Battery</b> . . . . .	<b>89</b>
<b>Dell Technical Support Policy (U.S. Only)</b> . . . . .	<b>90</b>
Definition of "Dell-Installed" Software and Peripherals . . . . .	91
Definition of "Third-Party" Software and Peripherals . . . . .	91
<b>Contacting Dell</b> . . . . .	<b>92</b>
Contact Numbers and Addresses . . . . .	92
Returning Items for Warranty Repair or Credit . . . . .	107
<b>Regulatory Information</b> . . . . .	<b>107</b>
FCC Notices (U.S. Only) . . . . .	109
NOM Information (Mexico Only) . . . . .	111
<b>Limited Warranties and Return Policy</b> . . . . .	<b>112</b>
One-Year Limited Warranty (U.S. Only) . . . . .	112
Two-Year Limited Warranty (U.S. Only) . . . . .	114
Three-Year Limited Warranty (U.S. Only) . . . . .	118
Four-Year Limited Warranty (U.S. Only) . . . . .	121
One-Year Limited Warranty (Canada Only) . . . . .	124
Two-Year Limited Warranty (Canada Only) . . . . .	126

Three-Year Limited Warranty (Canada Only) . . . . .	129
"Total Satisfaction" Return Policy (U.S. Only) . . . . .	133
One-Year End-User Manufacturer Guarantee (Latin America and the Caribbean Only) . . . . .	134
Index . . . . .	137





# Safety Instructions

Use the following safety guidelines to help protect your computer from potential damage and to ensure your own personal safety.

## When Using Your Computer

As you use your computer, observe the following safe-handling guidelines.

 **CAUTION:** Do not operate your computer with any cover(s) (including computer covers, bezels, filler brackets, front-panel inserts, and so on) removed.

- Your computer is equipped with one of the following:
  - A fixed-voltage power supply — Computers with a fixed-voltage power supply do not have a voltage selection switch on the back panel and operate at only one voltage (see the regulatory label on the outside of the computer for its operating voltage).
  - An auto-sensing voltage circuit — Computers with an auto-sensing voltage circuit do not have a voltage selection switch on the back panel and automatically detect the correct operating voltage.
  - A manual voltage selection switch — Computers with a voltage selection switch on the back panel must be manually set to operate at the correct operating voltage.

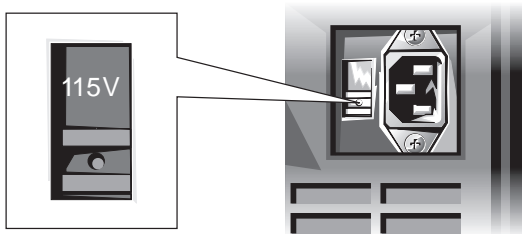

## Safety Instructions *(continued)*

To help avoid damaging a computer with a manual voltage selection switch, ensure that the voltage selection switch is set to match the AC power available at your location:

- 115 V/60 Hz in most of North and South America and some Far Eastern countries such as South Korea and Taiwan
- 100 V/50 Hz in eastern Japan and 100 V/60 Hz in western Japan

**NOTE:** The voltage selection switch must be set to the 115-V position even though the AC power available in Japan is 100 V.

- 230 V/50 Hz in some regions in the Caribbean and South America and most of Europe, the Middle East, and the Far East

Also, ensure that your monitor and attached devices are electrically rated to operate with the AC power available in your location.

- Before working inside the computer, unplug the computer to help prevent electric shock or system board damage. Certain system board components continue to receive power any time the computer is connected to AC power.
- To avoid shorting out your computer when disconnecting a network cable, first unplug the cable from the network adapter on the back of your computer, and then from the network jack. When reconnecting a network cable to your computer, first plug the cable into the network jack, and then into the network adapter.
- To help avoid possible damage to the system board, wait 5 seconds after turning off the computer before disconnecting a device from the computer.
- To help prevent electric shock, plug the computer and device power cables into properly grounded electrical outlets. These cables are equipped with 3-prong plugs to help ensure proper grounding. Do not use adapter plugs or remove the grounding prong from a cable. If you must use an extension cable, use a 3-wire cable with properly grounded plugs.

## Safety Instructions *(continued)*



- To help protect your computer from sudden, transient increases and decreases in electrical power, use a surge suppressor, line conditioner, or uninterruptible power supply (UPS).
- Be sure nothing rests on your computer's cables and that the cables are not located where they can be stepped on or tripped over.
- Do not push any objects into the openings of your computer. Doing so can cause fire or electric shock by shorting out interior components.
- Keep your computer away from radiators and heat sources. Also, do not block cooling vents. Avoid placing loose papers underneath your computer; do not place your computer in a closed-in wall unit or on a bed, sofa, or rug.

### When Working Inside Your Computer

Before you open the computer cover, perform the following steps in the sequence indicated.

 **CAUTION:** Do not attempt to service the computer yourself, except as explained in your online Dell documentation or otherwise provided to you. Always follow installation and service instructions closely.

 **NOTICE:** To help avoid possible damage to the system board, wait 5 seconds after turning off the computer before removing a component from the system board or disconnecting a device from the computer.

- 1 Perform an orderly computer shutdown using the operating system menu.
- 2 Turn off your computer and any devices.

## Safety Instructions *(continued)*

- 3 Ground yourself by touching an unpainted metal surface on the chassis, such as the metal around the card-slot openings at the back of the computer, before touching anything inside your computer.

While you work, periodically touch an unpainted metal surface on the computer chassis to dissipate any static electricity that might harm internal components.

- 4 Disconnect your computer and devices, including the monitor, from their electrical outlets. Also, disconnect any telephone or telecommunication lines from the computer.

Doing so reduces the potential for personal injury or shock.

- 5 Disconnect the power cable to your computer, and then press the power button to ground the system board.

In addition, take note of these safety guidelines when appropriate:

- When you disconnect a cable, pull on its connector or on its strain-relief loop, not on the cable itself. Some cables have a connector with locking tabs; if you are disconnecting this type of cable, press in on the locking tabs before disconnecting the cable. As you pull connectors apart, keep them evenly aligned to avoid bending any connector pins. Also, before you connect a cable, ensure that both connectors are correctly oriented and aligned.
- Handle components and cards with care. Do not touch the components or contacts on a card. Hold a card by its edges or by its metal mounting bracket. Hold a component such as a microprocessor chip by its edges, not by its pins.

 **CAUTION:** There is a danger of a new battery exploding if it is incorrectly installed. Replace the battery only with the same or equivalent type recommended by the manufacturer. Discard used batteries according to the manufacturer's instructions.

# Safety Instructions *(continued)*

## Protecting Against Electrostatic Discharge

Static electricity can harm delicate components inside your computer. To prevent static damage, discharge static electricity from your body before you touch any of your computer's electronic components, such as the microprocessor. You can do so by touching an unpainted metal surface on the computer chassis.

As you continue to work inside the computer, periodically touch an unpainted metal surface to remove any static charge your body may have accumulated.

You can also take the following steps to prevent damage from electrostatic discharge (ESD):

- Do not remove components from their antistatic packing material until you are ready to install the component in your computer. Just before unwrapping the antistatic packaging, discharge static electricity from your body.
- When transporting an electrostatic sensitive component, first place it in an antistatic container or packaging.
- Handle all electrostatic sensitive components in a static-safe area. If possible, use antistatic floor pads and workbench pads.

The following notice may appear throughout this document to remind you of these precautions:

 **NOTICE:** See "Protecting Against Electrostatic Discharge" in the safety instructions at the front of this guide.

## Ergonomic Computing Habits

 **CAUTION:** Improper or prolonged keyboard use may result in injury.

 **CAUTION:** Viewing the monitor screen for extended periods of time may result in eye strain.

## **Safety Instructions** *(continued)*



### **Battery Disposal**

Your computer uses a lithium coin-cell battery. The lithium coin-cell battery is a long-life battery, and it is very possible that you will never need to replace it. However, should you need to replace it, see page 89.

Do not dispose of the battery along with household waste. Contact your local waste disposal agency for the address of the nearest battery deposit site.

SECTION 1

## Setting Up

Connecting a Printer

Transferring Information to a New Computer  
(Windows XP Only)

Setting Up a Home and Office Network  
(Windows XP Only)

Turning Off the Computer

# Connecting a Printer

See the documentation that came with the printer for any recommended preparation procedures, such as:

- Removing the packaging
- Installing the toner or ink cartridge
- Loading paper

Then follow the instructions that came with the printer to connect it to the computer. If no information is provided, see the following sections.

## Parallel Printer

Follow the instructions that came with the parallel printer to connect it to the computer. If no information is provided, then follow the instructions in this section.

- 1 Turn off the computer (see page 20).



**NOTICE:** Use only a standard IEEE parallel cable measuring 3 m (10 ft) or less to connect the printer to the computer. Use of a nonstandard cable may prevent the printer from working.

- 2 Attach the parallel printer cable to the parallel connector on the computer and tighten the two screws. Attach the cable to the parallel connector on the printer and snap the two clips into the two notches.



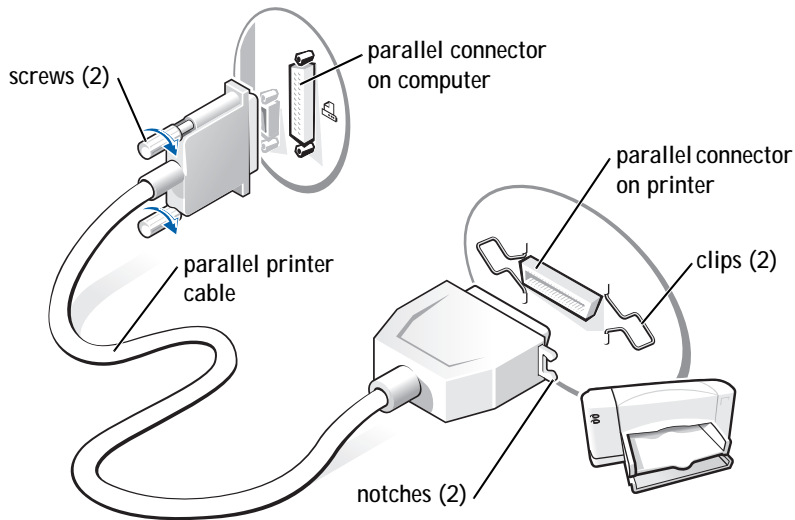

- 3 Turn on the printer and then turn on the computer. If the **Add New Hardware Wizard** window appears, click **Cancel**.
- 4 Install the printer driver if necessary (see "Installing the Printer Driver" on page 18).

## USB Printer

Follow the instructions that came with the USB printer to connect it to the computer. If no information is provided, then follow the instructions in this section.

- 1 Install the printer driver if necessary (see the following section).
- 2 Attach the USB printer cable to the USB connector on the computer and the printer. The USB connectors only fit one way.

 **HINT:** You can connect USB devices while the computer is turned on.

**HINT:** Your computer has four USB connectors on the back panel (see page 58).

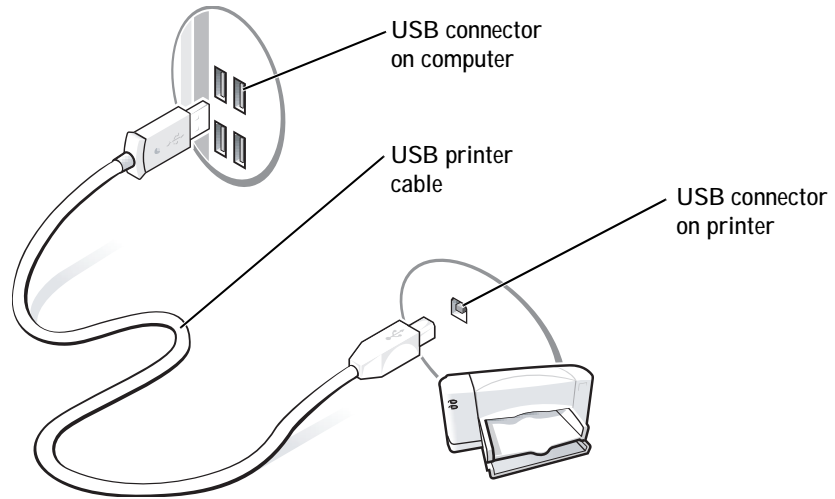

## Installing the Printer Driver

Follow the instructions that came with the printer to install printer drivers. If no information was provided with the printer, then refer to the following instructions.

If you need to install a printer driver, insert the printer installation CD into the CD or DVD drive. Then follow the prompts on the screen using the instructions that came with the printer.

If your printer installation CD does not automatically run, click the **Start** button on the Microsoft® Windows® desktop, click **Run**, and type `x:\setup.exe` (where *x* is the letter of your CD or DVD drive [usually drive D]). Then click **OK** and follow the prompts on your screen. If your printer installation CD still does not run, check the documentation that came with your printer for instructions on how to start the printer installation CD.

If you connect an older printer and it doesn't work after you install the driver, access the system setup program (see page 86) and ensure that the parallel port is set to operate in bidirectional mode.

To check if your printer driver is installed on a computer running the Windows XP operating system, click the **Start** button, click **Control Panel**, click **Printers and Other Hardware**, and then click **View installed printers or fax printers**. If your computer runs Windows 2000, click the **Start** button, point to **Settings**, and then click **Printers**. If your printer is listed in the **Printers** window, the printer is ready to use.

## Transferring Information to a New Computer (Windows XP Only)

Windows XP provides a **Files and Settings Transfer Wizard** to move data, such as e-mails, window sizes, toolbar settings, and Internet bookmarks, from one computer to another. First you collect the data from the source computer, and then you import the data to the new computer.

If the source computer uses another Windows operating system, the wizard can be launched from the Windows XP operating system CD or from a floppy disk created on the Windows XP computer. You may transfer the data to the new computer over a network or serial connection, or you may store it on a removable medium, such as a floppy disk, a Zip disk, or a writable CD.

- 1 On the computer running Windows XP, click the **Start** button, point to **All Programs**—> **Accessories**—> **System Tools**, and then click **Files and Settings Transfer Wizard**.
- 2 On the welcome screen, click **Next**.
- 3 On the **Which computer is this?** screen, select **New Computer**, and then click **Next**.
- 4 Follow the instructions on the screen.

 **HINT:** The CD that you need to place in your CD or DVD drive is titled *Operating System*.

## Setting Up a Home and Office Network (Windows XP Only)

Windows XP provides a Network Setup Wizard to guide you through the process of sharing files, printers, or an Internet connection between computers in a home or small office.

 **HINT:** Selecting the connection method This computer connects directly to the Internet enables the integrated firewall provided with Windows XP.

- 1 Click the **Start** button, point to **All Programs**—> **Accessories**—> **Communications**, and then click **Network Setup Wizard**.
- 2 On the welcome screen, click **Next**.
- 3 Click **checklist for creating a network**.
- 4 Complete the checklist and required preparations, and then return to the Network Setup Wizard.
- 5 Follow the instructions on the screen.

## Turning Off the Computer

 **NOTICE:** To prevent data loss, you must turn off your computer through the Start menu rather than by pressing the power button.

 **HINT:** If you are having difficulty turning off your computer, see "General Program Problems" on page 42.

### Windows XP

- 1 Save and close any open files and exit any open programs.
- 2 Click the **Start** button and then click **Turn off Computer**.
- 3 Click **Turn off**.

The computer automatically turns off after the shutdown process finishes.

- 4 Turn off your monitor and any other devices connected to power.

### Windows 2000

- 1 Save and exit any programs and files you have open.
- 2 Click the **Start** button, and then click **Shut Down**.
- 3 Click the pull-down menu under **What do you want the computer to do?**.

- 4 Click **Shut down** and then click **OK**.

The computer automatically turns off after the shutdown process finishes.

- 5 Turn off your monitor and any other devices connected to power.



SECTION 2
-----------

# Solving Problems

- Finding Solutions
- Accessing Help Files
- Power Problems
- Start-Up Error Messages
- Video and Monitor Problems
- Sound and Speaker Problems
- Printer Problems
- Scanner Problems
- Modem Problems
- Mouse Problems
- Keyboard Problems
- Drive Problems
- Network Problems
- Microsoft® Windows® Error Messages
- General Program Problems
- Internet Connection Problems
- E-Mail Problems
- Resolving Other Technical Problems
- Reinstalling Drivers
- Resolving Software and Hardware Incompatibilities
- Using System Restore
- Reinstalling Windows XP
- Reinstalling Windows 2000

# Finding Solutions

Sometimes it's difficult to figure out where to go for answers. Use this chart to help you quickly find the answers to your questions.

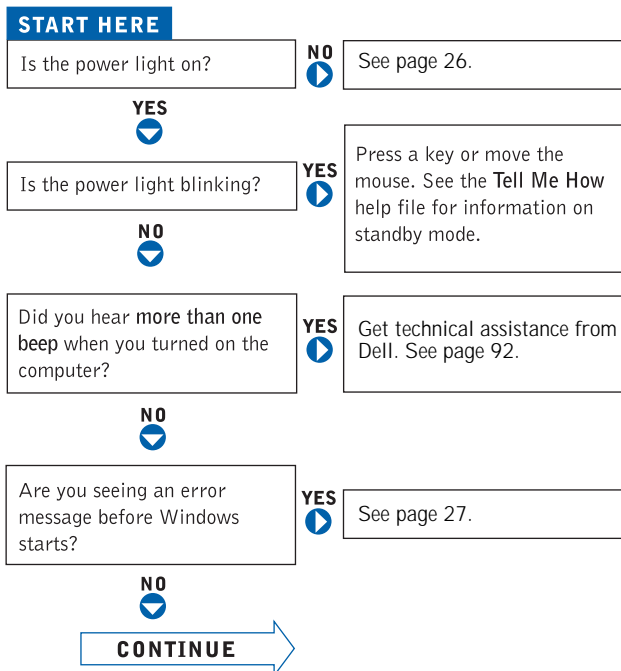



<p>Are you having a problem with...</p> <p><b>NO</b></p>	▶	video or the monitor?	<b>YES</b>	▶	See page 28.
		sound or the speakers?	<b>YES</b>	▶	See page 30.
		the printer?	<b>YES</b>	▶	See page 32.
		the modem?	<b>YES</b>	▶	See page 34.
		the mouse?	<b>YES</b>	▶	See page 36.
		the keyboard?	<b>YES</b>	▶	See page 37.
		the hard drive or a disk drive?	<b>YES</b>	▶	See page 37.
		the network adapter?	<b>YES</b>	▶	See page 40.
		the scanner?	<b>YES</b>	▶	See page 34.
		Windows error messages?	<b>YES</b>	▶	See page 41.
		a program?	<b>YES</b>	▶	See page 42.
		the Internet?	<b>YES</b>	▶	See page 43.
		your email?	<b>YES</b>	▶	See page 44.
	<p>Are you having some other type of problem?</p>	<b>YES</b>	▶		See page 45.

## Accessing Help Files

### TO ACCESS THE *Tell Me How* HELP FILE

#### *Microsoft® Windows® XP*

- 1 Click the **Start** button, and then click **Help and Support**.
- 2 Click **User and system guides**, and then click **User's guides**.
- 3 Click **Tell Me How**.

#### *Windows 2000*

Click the **Start** button, point to **Programs**, point to **User's Guides**, and then click **Tell Me How**.

### TO ACCESS HELP IN WINDOWS XP

- 1 Click the **Start** button, and then click **Help and Support**.
- 2 Type a word or phrase that describes your problem, and then click the arrow icon.
- 3 Click the topic that describes your problem.
- 4 Follow the instructions on the screen.

### TO ACCESS HELP IN WINDOWS 2000

- 1 Click the **Start** button, and then click **Help**.
- 2 Click the **Search** tab.
- 3 Type a word or phrase that describes your problem, and then click **List Topics**.
- 4 Click the topic that describes your problem, and then click **Display**.
- 5 Follow the instructions on the screen.

## Power Problems



**HINT:** See the *Tell Me How* help file for information on the standby mode.

**CHECK THE POWER LIGHT** — When the power light is lit or blinking, the computer has power. If the power light is blinking, the computer is in standby mode—press a key on the keyboard or move the mouse.

**TEST THE ELECTRICAL OUTLET** — Ensure that the electrical outlet is working by testing it with another device, such as a lamp.

**CHECK THE POWER CABLE CONNECTION** — Be sure that the power cable is firmly inserted into the electrical outlet and the computer power connector.

**CONNECT THE COMPUTER DIRECTLY TO AN ELECTRICAL OUTLET** — Bypass power protection devices, power strips, and the extension cable to verify that the computer turns on.

**SWAP THE COMPUTER AND MONITOR POWER CABLES** — Swap the computer and monitor power cables to determine if the power cable is defective.

**CHECK FOR INTERFERENCE** — Electrical appliances on the same circuit or operating near the computer can cause interference. Other causes of interference: power extension cables, keyboard and mouse extension cables, too many devices on a power strip, or multiple power strips connected to the same electrical outlet.

**CHECK THE POWER PROPERTIES** — See the *Tell Me How* help file or search for the keyword *standby* in the Help and Support Center (*Help* in Windows 2000). To access help files, see page 26.

## Start-Up Error Messages

**OPERATING SYSTEM NOT FOUND** — Call Dell for technical assistance (see page 92).

**INSERT BOOTABLE MEDIA** — The operating system is trying to boot to a nonbootable floppy disk or CD. Insert a bootable floppy disk or CD.

**NON-SYSTEM DISK ERROR** — There is a floppy disk in the floppy drive. Remove the floppy disk and restart the computer.

# Video and Monitor Problems

## If the screen is blank

 **HINT:** See the documentation that came with your monitor for fault indications and troubleshooting procedures specific to your monitor.

**CHECK THE VIDEO CABLE CONNECTION** — Check for bent pins (most video cable connectors have missing pins, but not bent pins). Ensure that the video cable is connected as shown on the *START HERE* sheet for your computer.

**PRESS THE MONITOR POWER BUTTON** — Be sure that you firmly pressed the monitor power button.

**CHECK THE POWER LIGHT** — When the power light is lit or blinking, the monitor has power. If the power light is blinking, press a key on the keyboard or move the mouse.

**TEST THE ELECTRICAL OUTLET** — Ensure that the electrical outlet is working by testing it with another device, such as a lamp.

**SWAP THE COMPUTER AND MONITOR POWER CABLES** — Swap the computer and monitor power cables to determine if the power cable is defective.

**TEST THE VIDEO EXTENSION CABLE (IF USED)** — If you are using a video extension cable and removing the cable solves the problem, the cable is defective.

**TEST THE MONITOR** — If another monitor is available, connect it to the computer.

**CHECK THE BACK PANEL LIGHTS** — If all four lights below the serial connector are not green, call Dell for technical assistance (see page 92).

**CHECK THE POWER PROPERTIES** — See the *Tell Me How* help file or search for the keyword *standby* in the Help and Support Center (*Help* in Windows 2000). To access help files, see page 26.

## If the screen is difficult to read

**ADJUST THE CONTRAST AND BRIGHTNESS** — See the documentation that came with your monitor for instructions on adjusting the contrast and brightness.

**MOVE THE SUBWOOFER AWAY FROM THE MONITOR** — If your speaker system includes a subwoofer, ensure that the subwoofer is at least 2 ft (60 cm) away from the monitor.

**MOVE THE MONITOR AWAY FROM EXTERNAL POWER SOURCES** — Fans, fluorescent lights, halogen lamps, and other electrical devices can cause the screen image to appear "shaky." Turn off nearby devices to check for interference.

**ROTATE THE MONITOR TO FACE A DIFFERENT DIRECTION** — Eliminate sunlight glare, which can cause poor picture quality.

**DEGAUSS (DEMAGNETIZE) THE MONITOR** — See the documentation that came with your monitor.

**RUN THE MONITOR SELF-TEST** — See the documentation that came with your monitor.

**RESTORE THE RECOMMENDED SETTINGS** — Restore the original resolution and refresh rate settings. See the *Tell Me How* help file for instructions. To access help files, see page 26.

**CHECK FOR ADDITIONAL ADJUSTMENTS** — See the documentation that came with your monitor for any additional adjustments that your monitor may require.

**ADJUST THE WINDOWS DISPLAY SETTINGS***Windows XP*

- 1 Click the **Start** button, and then click **Control Panel**.
- 2 Click **Appearance and Themes**.
- 3 Click **Display**, and then click the **Settings** tab.
- 4 Try different settings for **Screen resolution** and **Color quality**.

*Windows 2000*

- 1 Click the **Start** button, point to **Settings**, and then click **Control Panel**.
- 2 Double-click the **Display** icon, and then click the **Settings** tab.
- 3 Try different settings for **Colors** and **Screen area**.

**CHECK FOR INTERRUPT REQUEST CONFLICTS** — See page 47.



**HINT:** The volume control in some MP3 players overrides the Windows volume setting. If you have been listening to MP3 songs, make sure that you did not turn the player volume down or off.

## Sound and Speaker Problems

### No sound from speakers

**CHECK THE SPEAKER CABLE CONNECTIONS** — Ensure that the speakers are connected as shown on the setup diagram supplied with the speakers.

**ENSURE THAT THE SUBWOOFER AND THE SPEAKERS ARE TURNED ON** — See the setup diagram supplied with the speakers. If your speakers have volume controls, adjust the volume, bass, or treble to eliminate distortion.

**ADJUST THE WINDOWS VOLUME CONTROL** — In Windows XP, click the speaker icon in the lower-right corner of your screen. In Windows 2000, double-click the speaker icon in the lower-right corner of your screen. Be sure that the volume is turned up and that the sound is not muted.

**DISCONNECT HEADPHONES FROM THE HEADPHONE CONNECTOR** — Sound from the speakers is automatically disabled when headphones are connected to the computer's front-panel headphone connector.

**ENABLE DIGITAL MODE** — In Windows XP, your speakers do not work if the CD drive is not operating in digital mode. To enable digital mode:

- 1 Click the **Start** button, click **Control Panel**, and then click **Sounds, Speech, and Audio Devices**.
- 2 Click **Sounds and Audio Devices**.
- 3 Click the **Hardware** tab.
- 4 Double-click the name of your CD drive.
- 5 Click the **Properties** tab.
- 6 Check the **Enable digital CD audio for this CD-ROM device** box.

**TEST THE ELECTRICAL OUTLET** — Ensure that the electrical outlet is working by testing it with another device, such as a lamp.

**ELIMINATE POSSIBLE INTERFERENCE** — Turn off nearby fans, fluorescent lights, or halogen lamps to check for interference.

**RUN THE SPEAKER DIAGNOSTICS** — Some speaker systems have self-diagnostics. See the speaker documentation for diagnostics instructions.

**REINSTALL THE AUDIO (SOUND) DRIVER** — See page 45.

**CHECK FOR INTERRUPT REQUEST CONFLICTS** — See page 47.

## No sound from headphones

**CHECK THE HEADPHONE CABLE CONNECTION** — Ensure that the headphone cable is securely inserted into the headphone connector (see page 58).

**ADJUST THE WINDOWS VOLUME CONTROL** — Click or double-click the speaker icon in the lower-right corner of your screen. Ensure that the volume is turned up and that the sound is not muted.



**HINT:** If you need technical assistance for your printer, call the printer's manufacturer (see the documentation that came with the printer for the correct phone number). Dell does not cover the printer's warranty.

**DISABLE DIGITAL MODE** — In Windows XP, your headphones do not work if the CD drive is operating in digital mode. To disable digital mode:

- 1 Click the **Start** button, click **Control Panel**, and then click **Sounds, Speech, and Audio Devices**.
- 2 Click **Sounds and Audio Devices**.
- 3 Click the **Hardware** tab.
- 4 Double-click the name of your CD drive.
- 5 Click the **Properties** tab.
- 6 Uncheck the **Enable digital CD audio for this CD-ROM device** box.

## Printer Problems

### If you cannot print to a parallel port printer

**VERIFY THE PRINTER CABLE CONNECTIONS** — Ensure that the printer cable is connected as described on page 16.

**ENSURE THAT THE PRINTER IS TURNED ON** — See the documentation supplied with the printer.

#### VERIFY THAT THE PRINTER IS RECOGNIZED BY WINDOWS

##### *Windows XP*

- 1 Click the **Start** button.
- 2 Click **Control Panel**.
- 3 Click **Printers and Other Hardware**.
- 4 Click **View installed printers or fax printers**. If the printer is listed, right-click the printer icon.
- 5 Click **Properties**, and then select the **Ports** tab. Ensure that the **Print to the following port(s):** setting is **LPT1 (Printer Port)**.

##### *Windows 2000*

- 1 Click the **Start** button, point to **Settings**, and then click **Printers**.  
If the printer is listed, right-click the printer icon.
- 2 Click **Properties**, and then the **Ports** tab. Ensure that the **Print to the following port(s):** setting is **LPT1 (Printer Port)**.



**TEST THE ELECTRICAL OUTLET** — Ensure that the electrical outlet is working by testing it with another device, such as a lamp.

**REINSTALL THE PRINTER DRIVER** — See page 18.

**CHECK FOR INTERRUPT REQUEST CONFLICTS** — See page 47.

## If you cannot print to a USB printer

**VERIFY THE PRINTER CABLE CONNECTIONS** — Ensure that the printer cable is connected as described on page 17.

**ENSURE THAT THE PRINTER IS TURNED ON** — See the documentation supplied with the printer.

### **VERIFY THAT THE PRINTER IS RECOGNIZED BY WINDOWS**

#### *Windows XP*

- 1 Click the **Start** button.
- 2 Click **Control Panel**.
- 3 Click **Printers and Other Hardware**.
- 4 Click **View installed printers or fax printers**. If the printer is listed, right-click the printer name.
- 5 Click **Properties**, and then select the **Ports** tab. Ensure that the **Print to the following port(s)**: setting is **USB**.

#### *Windows 2000*

- 1 Click the **Start** button, point to **Settings**, and then click **Printers**.  
If the printer is listed, right-click the printer icon.
- 2 Click **Properties**, and then select the **Ports** tab. Ensure that the **Print to the following port(s)**: setting is **USB**.

**TEST THE ELECTRICAL OUTLET** — Ensure that the electrical outlet is working by testing it with another device, such as a lamp.

**REINSTALL THE PRINTER DRIVER** — See page 18.

 **HINT:** If you need technical assistance for your scanner, call the scanner's manufacturer (see the documentation that came with the scanner for the correct phone number). Dell does not cover the scanner's warranty.

**CHECK FOR INTERRUPT REQUEST CONFLICTS** — See page 47.

## Scanner Problems

**CHECK THE POWER CABLE CONNECTION** — Ensure that the scanner power cable is firmly connected to a working electrical power source and that the scanner is turned on.

**CHECK THE SCANNER CABLE CONNECTION** — Ensure that the scanner cable is firmly connected to the computer and to the scanner.

**UNLOCK THE SCANNER** — Ensure that your scanner is unlocked if it has a locking tab or button.

**REINSTALL THE SCANNER DRIVER** — Reinstall the scanner driver. See the scanner documentation for instructions.

**CHECK FOR INTERRUPT REQUEST CONFLICTS** — See page 47.

 **HINT:** Connect the modem to an analog telephone jack only. The modem does not operate while it is connected to a digital telephone network.

## Modem Problems

**CHECK THE CONNECTION** — Verify that the telephone line is connected to the green connector on the modem. (The green line-in connector has either a LINE IN label or a connector-shaped icon next to it.) Make sure you hear a click when you insert the telephone line connector.

**CHECK THE TELEPHONE JACK** — Disconnect the telephone line from the modem and connect it to a telephone. Listen for a dial tone.

**CONNECT THE MODEM DIRECTLY TO THE TELEPHONE WALL JACK** —

If you have other telephone devices sharing the line, such as an answering machine, fax machine, surge protector, or line splitter, then bypass them and connect the modem directly to the telephone wall jack with the telephone line.

**CHECK THE TELEPHONE LINE** — Try using a different telephone line. If you are using a line that is 10 ft (3 m) or more in length, try a shorter one.

**VERIFY THAT THE MODEM IS COMMUNICATING WITH WINDOWS**

*Windows XP*

- 1 Click the **Start** button, and then click **Control Panel**.
  - 2 Click **Printers and Other Hardware**.
  - 3 Click **Phone and Modem Options**.
  - 4 Click the **Modems** tab.
  - 5 Click the COM port for your modem.
  - 6 Click **Properties**, click the **Diagnostics** tab, and then click **Query Modem** to verify that the modem is communicating with Windows.
- If all commands receive responses, the modem is operating properly.

*Windows 2000*

- 1 Click the **Start** button, point to **Settings**, and click **Control Panel**.
  - 2 Double-click **Phone and Modem Options**.  
If there are multiple entries for the same modem or modems listed that are not installed, delete the entries and restart the computer.
  - 3 Click the **Modems** tab.
  - 4 Click the COM port for your modem.
  - 5 Click **Properties**, click the **Diagnostics** tab, and then click **Query Modem** to verify that the modem is communicating with Windows.
- If all commands receive responses, the modem is operating properly.

**BE SURE THAT YOU HAVE SUBSCRIBED TO AN INTERNET SERVICE PROVIDER** — Contact an Internet service provider to subscribe.

**CHECK FOR INTERRUPT REQUEST CONFLICTS** — See page 47.

## Mouse Problems

### IF YOU CONNECTED THE MOUSE BEFORE TURNING ON THE COMPUTER, RECONNECT THE MOUSE CABLE

- 1 Press <Ctrl><Esc> to display the **Start** menu.
- 2 In Windows XP, type u, press the keyboard arrow keys to highlight **Shut down** or **Turn Off**, and then press <Enter>. In Windows 2000, press the keyboard arrow keys to highlight **Shut Down**, and then press <Enter>.
- 3 After the computer turns off, reconnect the mouse cable as shown on the *START HERE* sheet for your computer.
- 4 Start the computer.

### IF YOU CONNECTED THE MOUSE AFTER TURNING ON THE COMPUTER, REMOVE THE POWER CABLE, AND THEN RECONNECT THE MOUSE CABLE — If the mouse is connected after the power is turned on, the mouse will appear to be nonfunctional. To make the mouse function properly:

- 1 While your computer is on, remove the power cable from the back of the computer.
- 2 Connect the mouse to the computer.
- 3 Reconnect the power cable.
- 4 Turn on your computer.

Pressing the power button does not clear the computer's settings and does not restore mouse functionality.

### CHECK THE MOUSE SETTINGS

#### *Windows XP*

- 1 Click the **Start** button, click **Control Panel**, and then click **Printers and Other Hardware**.
- 2 Click **Mouse**.
- 3 Try adjusting the settings.

#### *Windows 2000*

- 1 Click the **Start** button, point to **Settings**, and then click **Control Panel**.
- 2 Double-click the **Mouse** icon.
- 3 Try adjusting the settings.

CHECK FOR INTERRUPT REQUEST CONFLICTS — See page 47.

# Keyboard Problems

**RECONNECT THE KEYBOARD CABLE** — Shut down the computer (see page 20), reconnect the keyboard cable as shown on the *START HERE* sheet for your computer, and then restart the computer.

**CHECK FOR INTERRUPT REQUEST CONFLICTS** — See page 47.

# Drive Problems

## If you cannot save a file to a floppy disk

**ENSURE THAT WINDOWS RECOGNIZES THE DRIVE** — In Windows XP, click the **Start** button, and then click **My Computer**. In Windows 2000, double-click the **My Computer** icon on the Windows desktop. If the floppy drive is not listed, perform a full scan with your antivirus software to check for and remove viruses. Viruses can sometimes prevent Windows from recognizing the drive.

**TEST THE DRIVE WITH ANOTHER FLOPPY DISK** — Insert another floppy disk to eliminate the possibility that the original floppy disk is defective.

**CANNOT SAVE FILES TO A FLOPPY DISK** — Ensure that the floppy disk is not full or write-protected (locked). See the following illustration.

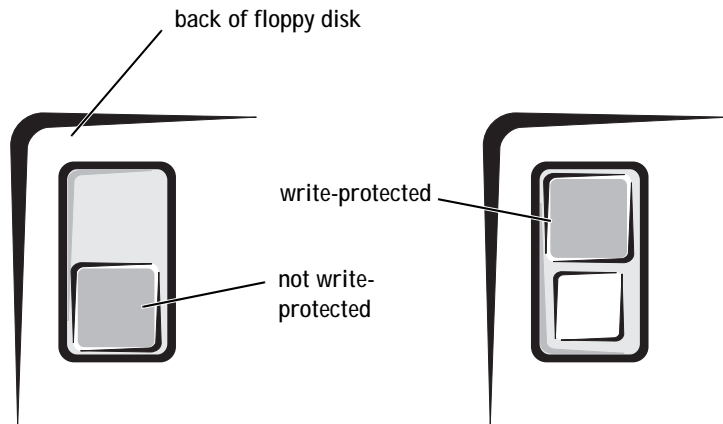

### If you cannot play a music CD or install a program from a CD

**HINT:** High-speed CD drive vibration is normal and may cause noise. This does not indicate a defect in the drive or the CD.

**ENSURE THAT WINDOWS RECOGNIZES THE DRIVE** — In Windows XP, click the speaker icon in the lower-right corner of your screen. In Windows 2000, double-click the **My Computer** icon on the Windows desktop. If the CD drive is not listed, perform a full scan with your antivirus software to check for and remove viruses. Viruses can sometimes prevent Windows from recognizing the drive.

**TEST THE DRIVE WITH ANOTHER CD** — Insert another CD to eliminate the possibility that the original CD is defective.

**CLEAN THE DISC** — See the *Tell Me How* help file for instructions. To access help files, see page 26.

**ADJUST THE WINDOWS VOLUME CONTROL** — In Windows XP, click the speaker icon in the lower-right corner of your screen. In Windows 2000, double-click the speaker icon in the lower-right corner of your screen. Be sure that the volume is turned up and that the sound is not muted.

**IF HEADPHONES ARE CONNECTED TO THE FRONT-PANEL HEADPHONE CONNECTOR, CHECK FOR SOUND FROM THE HEADPHONES** — Sound from the speakers is automatically disabled when headphones are connected to the computer's front-panel headphone connector.

**CHECK THE SPEAKERS AND SUBWOOFER** — See page 30.

## If you cannot play a DVD movie

**ENSURE THAT WINDOWS RECOGNIZES THE DRIVE** — In Windows XP, click the **Start** button, and then click **My Computer**. In Windows 2000, double-click the **My Computer** icon on the Windows desktop. If the DVD drive is not listed, perform a full scan with your antivirus software to check for and remove viruses. Viruses can sometimes prevent Windows from recognizing the drive.

**TEST THE DRIVE WITH ANOTHER DVD** — Insert another DVD to eliminate the possibility that the original DVD is defective.

**CLEAN THE DISC** — See the *Tell Me How* help file for instructions.

## If the CD-RW drive stops writing

**TURN OFF STANDBY IN WINDOWS BEFORE WRITING TO A CD-RW DISC** — See the *Tell Me How* help file or search for the keyword *standby* in the Help and Support Center (*Help* in Windows 2000). To access help files, see page 26.

**CHANGE THE WRITE SPEED TO A SLOWER RATE** — The CD-RW drive must receive a steady stream of data when writing. If the stream is interrupted, an error occurs. Closing all programs before writing to the CD-RW may also alleviate the problem.

 **HINT:** Because of different worldwide file types, not all DVD titles work in all DVD drives.

 **HINT:** If you disable standby mode to write to a CD-RW drive, remember to reenable standby mode when you finish writing to the CD.

## If you have a hard drive problem

### **RUN SCANDISK**

- 1 In Windows XP click the **Start** button, and then click **My Computer**. In Windows 2000 double-click the **My Computer** icon on the Windows desktop.
- 2 Right-click on the drive letter (local disk) that you want to scan for errors, and then click **Properties**.
- 3 Click the **Tools** tab.
- 4 Under **Error-checking**, click **Check Now**.
- 5 Click **Start**.

**CHECK FOR INTERRUPT REQUEST CONFLICTS** — See page 47.

## Network Problems

**CHECK THE NETWORK CABLE CONNECTOR** — Ensure that the network cable connector is firmly connected to the connector on the computer and the network wall jack as shown on the *START HERE* sheet for your computer.

**CHECK THE NETWORK LIGHTS ON THE BACK OF THE COMPUTER** — A green light indicates a 10-Mbps network connection, and an orange light indicates a 100-Mbps network connection. The light blinks amber when there is any network traffic. If the light is dark, try replacing the network cable.

**RESTART THE COMPUTER** — Try to log on to the network again.

**CONTACT YOUR NETWORK ADMINISTRATOR** — Verify that your network settings are correct and that the network is functioning.

**CHECK FOR INTERRUPT REQUEST CONFLICTS** — See page 47.



# Microsoft® Windows® Error Messages

**x:\ IS NOT ACCESSIBLE. THE DEVICE IS NOT READY** — Insert a disk into the drive and try again.

**A FILENAME CANNOT CONTAIN ANY OF THE FOLLOWING CHARACTERS: \ / : \* ? " < > | —** Do not use these characters in filenames.

**NOT ENOUGH MEMORY OR RESOURCES. CLOSE SOME PROGRAMS AND TRY AGAIN** — You have too many programs open. Close all windows and open the program that you want to use. In some cases, you might have to restart your computer to restore computer resources. If so, try running the program that you want to use first.

**THE FILE BEING COPIED IS TOO LARGE FOR THE DESTINATION DRIVE** — The file that you are trying to copy is too large to fit on the disk. Try copying the file to a blank disk or use a larger-capacity disk.

**A REQUIRED .DLL FILE WAS NOT FOUND** — The program that you are trying to open is missing an essential file. To remove and then reinstall the program:

## *Windows XP*

- 1 Click the **Start** button.
- 2 Click **Control Panel**.
- 3 Click **Add or Remove Programs**.
- 4 Select the program you want to remove.
- 5 Click the **Change or Remove Program** icon.
- 6 See the program documentation for installation instructions.

## *Windows 2000*

- 1 Click the **Start** button, point to **Settings**, and then click **Control Panel**.
- 2 Double-click the **Add/Remove Programs** icon.
- 3 Select the program that you want to remove.
- 4 Click **Change/Remove** and follow the prompts on the screen.
- 5 See the program documentation for installation instructions.

# General Program Problems

## A program crashes

**SEE THE SOFTWARE DOCUMENTATION** — Many software manufacturers maintain websites with information that may help you to solve the problem.

## A program stops responding

### END THE PROGRAM

- 1 Simultaneously press < Ctrl> < Shift> < Esc> .
- 2 Click the **Applications** tab, and then select the program that is no longer responding.
- 3 Click the **End Task** button.

## A program error causes the system to lock up

 **HINT:** ScanDisk may run when you restart the computer. Follow the instructions on the screen.

**TURN THE COMPUTER OFF** — If your computer locks up and you are unable to get a response by pressing a key on your keyboard or moving your mouse, press and hold the power button for at least 8 to 10 seconds until the computer turns off. Then press the power button again to turn on the computer. You might lose data if you are unable to perform a Microsoft Windows shutdown.

## A solid blue screen appears

 **HINT:** ScanDisk may run when you restart the computer. Follow the instructions on the screen.

**TURN THE COMPUTER OFF** — If your computer locks up and you are unable to get a response by pressing a key on your keyboard or moving your mouse, press and hold the power button for at least 8 to 10 seconds until the computer turns off. Then press the power button again to turn on the computer. The solid blue screen appears because you were not able to perform a proper Windows shutdown. You might lose data if you are unable to perform a Microsoft Windows shutdown.

## A program is designed for an earlier Windows operating system

### RUN THE PROGRAM COMPATIBILITY WIZARD

Windows XP provides a Program Compatibility Wizard that configures a program to run in an environment more similar to older Windows operating system environments.

- 1 Click the **Start** button, point to **All Programs**—> **Accessories**, and then click **Program Compatibility Wizard**.
- 2 On the welcome screen, click **Next**.
- 3 Follow the instructions on the screen.

## Internet Connection Problems

If you have a problem with your Internet connection

REVIEW "MODEM PROBLEMS" — See page 34.

**TURN OFF CALL WAITING (CATCH-PHONE)** — See your telephone directory for instructions on deactivating this feature. Then adjust the dial-up networking connection properties.

*Windows XP*

- 1 Click the **Start** button, and then click **Control Panel**.
- 2 Click **Printers and Other Hardware**, and then click **Phone and Modem Options**.
- 3 Click to highlight your connection type in the displayed list.
- 4 Click the **Dialing Rules** tab, and then click the **Edit** button.
- 5 Click to place a checkmark in the **To Disable Call Waiting** box.
- 6 Select the disable code from the drop down menu (for example, \*70).
- 7 Click **Apply**, and then click **OK**.

*Windows 2000*

- 1 Click the **Start** button, point to **Settings**, and then click **Control Panel**.
- 2 Double-click the **Phone and Modems Options** icon.
- 3 In the **Locations** window, select the location for which you want to disable call waiting, and then click **Edit**.
- 4 Ensure that **To disable call waiting, dial:** is checked and then select the proper code according to the information in your telephone directory.
- 5 Click **Apply** and then click **OK**.
- 6 Close the **Phone and Modems Options** window.
- 7 Close the Control Panel.

**BE SURE THAT YOU HAVE SUBSCRIBED TO AN INTERNET SERVICE PROVIDER** — Contact an Internet service provider to subscribe.

## E-Mail Problems

**ENSURE THAT YOU ARE CONNECTED TO THE INTERNET** — With the Outlook Express e-mail program open, click **File**. If **Work Offline** has a check next to it, click the check to remove it and connect to the Internet.

**CONTACT YOUR INTERNET SERVICE PROVIDER** — Contact your Internet service provider for assistance.

# Resolving Other Technical Problems

**GO TO THE DELL | SUPPORT WEBSITE** — Go to **support.dell.com** for help with general usage, installation, and troubleshooting questions. See "Dell Technical Support Policy" on page 90 for a description of the hardware and software support provided by Dell.

**E-MAIL DELL** — Go to **support.dell.com**, and then click **E-Mail Dell** in the **Communicate** list. Send an e-mail message to Dell about your problem; you can expect to receive an e-mail message from Dell within hours. See "Dell Technical Support Policy" on page 90 for a description of the hardware and software support provided by Dell.

**CALL DELL** — If you cannot solve your problem using the Dell | Support website or e-mail service, call Dell for technical assistance (see page 92). See "Dell Technical Support Policy" on page 90 for a description of the hardware and software support provided by Dell.

## Reinstalling Drivers

 **NOTICE:** The Dell | Support website, [support.dell.com](http://support.dell.com), and the *Dell Dimension ResourceCD* provide approved drivers for Dell™ computers. If you install drivers obtained from other sources, your computer might not work correctly.

A driver is a software program that allows a hardware device controller to function properly and to communicate with the computer. Sometimes you can fix a device problem by reinstalling its driver:

- 1 From the Windows desktop, insert the *Dell Dimension ResourceCD* into the CD or DVD drive.

If this is your first time to use the *ResourceCD*, go to step 2. If not, go to step 5.

- 2 When the **ResourceCD Installation** program starts, follow the prompts on the screen.
- 3 When the **InstallShield Wizard Complete** window appears, remove the *ResourceCD* and click **Finish** to restart the computer.

 **HINT:** The *ResourceCD* displays drivers only for hardware that Dell installed at the time of purchase. If you installed any additional hardware, those drivers may not be displayed by the *ResourceCD*. If those drivers are not displayed, exit the *ResourceCD* program and refer to the documentation and drivers that came with that product.

4 When you see the Windows desktop, reinsert the *ResourceCD* into the CD or DVD drive.

5 At the **Welcome Dell System Owner** screen, click **Next**.

A message appears that says the *ResourceCD* is detecting hardware in your computer.

The drivers that are used by your computer are automatically displayed in the **My Drivers—The ResourceCD has identified these components in your system** window.

6 Click the driver that you want to reinstall and follow the instructions on the screen.

If a particular driver is not listed, then that driver is not required by your operating system.

To view other contents on the *ResourceCD*:

1 Verify that your computer is selected in the **System Model** list.

2 Verify that your operating system is selected in the **Operating System** list.

3 Select the type of device in the **Device Type** list.



**NOTICE:** The *ResourceCD* contains drivers for devices that are not part of your computer. Only reinstall the specific drivers for hardware included in your computer. Otherwise, your computer might not work correctly.

4 Select a topic in the **Topic** list.

If you select **Drivers** in the **Topic** list and a particular driver is not listed, then that driver is not required by your operating system.

### Using the Windows XP Device Driver Rollback

The Windows XP Device Driver Rollback can replace a device driver with the previously installed version if you install a new device driver that causes system instability. If you cannot reinstall your previous driver with the Driver Rollback process, then use System Restore (see page 49) to attempt to return your operating system to its previous operating state before the new device driver installation:

1 Click the **Start** button, and then right-click **My Computer**.

2 Click **Properties**.

- 3 Click the **Hardware** tab, and then click **Device Manager**.
- 4 In the **Device Manager** window, right-click the device for which the new driver was installed, and then click **Properties**.
- 5 Click the **Drivers** tab.
- 6 Click **Roll Back Driver**.

## Resolving Software and Hardware Incompatibilities

Windows XP and Windows 2000 IRQ conflicts occur if a device either is not detected during the operating system setup or is detected but incorrectly configured.

### Windows XP

To check for conflicts on a computer running Windows XP:

- 1 Click the **Start** button, and then click **Control Panel**.
- 2 Click **Performance and Maintenance**, and then click **System**.
- 3 Click the **Hardware** tab, and then click the **Device Manager** button.
- 4 In the **Device Manager** list, check for conflicts with the other devices.

Conflicts are indicated by a yellow exclamation point (!) beside the conflicting device or a red x if the device has been disabled.

- 5 Double-click any conflicting device listed to bring up the **Properties** window so you can determine what needs to be reconfigured or removed from the **Device Manager**.

Resolve these conflicts before checking specific devices.

- 6 Double-click the malfunctioning device type in the **Device Manager** list.
- 7 Double-click the icon for the specific device in the expanded list.

The **Properties** window appears.

- 8 Resolve any IRQ conflicts.

If there is an IRQ conflict, the **Device** status area in the **Properties** window reports what cards or devices are sharing the device's IRQ.

You can also use the Windows XP Hardware Troubleshooter. To use the troubleshooter, click the **Start** button and click **Help and Support**. Type `hardware troubleshooter` in the **Search** field, and then click the arrow to start the search. Click **Hardware Troubleshooter** in the **Search Results** list. In the **Hardware Troubleshooter** list, click **I need to resolve a hardware conflict on my computer**, and then click **Next**.

## Windows 2000

To check for conflicts on a computer running Windows 2000:

- 1 Click the **Start** button, point to **Settings**, and click **Control Panel**.
- 2 In the **Control Panel**, double-click **System**.
- 3 Click the **Hardware** tab.
- 4 Click **Device Manager**.
- 5 Click **View**, and then click **Resources by connection**.
- 6 Double-click **Interrupt request (IRQ)** to view the IRQ assignments.  
Conflicts are indicated by a yellow exclamation point (!) beside the conflicting device or a red x if the device has been disabled.
- 7 Double-click any conflicting device listed to bring up the **Properties** window so you can determine what needs to be reconfigured or removed from the **Device Manager**. Resolve these conflicts before checking specific devices.
- 8 Double-click the malfunctioning device type in the **Device Manager** list.
- 9 Double-click the icon for the specific device in the expanded list.  
The **Properties** window appears.
- 10 If there is an IRQ conflict, the **Device status** area in the **Properties** window reports what cards or devices are sharing the device's IRQ. Resolve the IRQ conflicts.



You can also use the Windows 2000 Hardware Troubleshooter. To use the troubleshooter, click the **Start** button and click **Help**. Click **Troubleshooting and Maintenance** on the **Contents** tab, click **Windows 2000 troubleshooters**, and then click **Hardware**. In the **Hardware Troubleshooter** list, click **I need to resolve a hardware conflict on my computer**, and then click **Next**.

## Using System Restore

Windows XP provides a System Restore feature that allows you to return your computer to an earlier operating state if changes to the computer's hardware or software (including new hardware or program installations), or other system settings, have left the computer in an undesirable operating state. You can also undo the last System Restore.

System Restore automatically creates system checkpoints. You can also manually create your own checkpoints by creating Restore Points. To limit the amount of hard disk space used, older restore points will be automatically purged.

If your computer experiences an operating system problem, you can use System Restore from Safe Mode or Normal Mode to return your computer to an earlier operating state.

System Restore does not cause you to lose personal files stored in the **My Documents** folder, data files, or e-mail messages after restoring the computer to an earlier time. If you restore the computer to a point before you installed a program, the program's data files won't be lost, but you will have to reinstall the actual program again.

 **NOTICE:** It is important to make regular backups of your data files. System Restore does not monitor changes to or recover your data files. If the original data on the hard disk is accidentally erased or overwritten, or becomes inaccessible because of a hard disk malfunction, you will need your backup files to recover the lost or damaged data.

System Restore is enabled on your new computer. However, if you reinstall Windows XP with less than 200 MB of free hard-disk space available, System Restore is automatically disabled. To see if System Restore is enabled:

- 1 Click the **Start** button, and then click **Control Panel**.
- 2 Click **Performance and Maintenance**.
- 3 Click **System**.
- 4 Click the **System Restore** tab.
- 5 Make sure that **Turn off System Restore** is unchecked.

Before proceeding with any System Restore function, Dell recommends that you thoroughly read Microsoft's information about using System Restore. To access this information:

- 1 Click the **Start** button, point to **All Programs**—> **Accessories**—> **System Tools**, and then click **System Restore**.
- 2 Click **Help** in the upper-right corner of the **Welcome to System Restore** screen.

## Creating a Restore Point

### Using the XP System Restore Wizard

In Windows XP you can manually create restore points or you can use the System Restore Wizard to create the restore points for you. To use the System Restore Wizard, click the **Start** button, click **Help and Support**, click **System Restore**, and then follow the instructions on the screen. You can also create and name a restore point if you are logged on as the computer administrator or a user with administrator rights.

### Manually Creating the Restore Points

- 1 Click the **Start** button, point to **All Programs**—> **Accessories**—> **System Tools**, and then click **System Restore**.
- 2 Click **Create a restore point**.
- 3 Click **Next**.

- 4 Type a name for your new restore point in the **Restore point description** field.

The present date and time are automatically added to your restore point.

- 5 Click **Create**.
- 6 Click **OK**.

## Restoring the Computer to an Earlier Operating State

If problems occur after installing a device driver, first try using Device Driver Rollback (see page 46). If that is unsuccessful, then use System Restore.

➔ **NOTICE:** Before restoring the computer to an earlier time, save and close all open files and close all open programs. Do not alter, open, or delete any files or programs until the system restoration is complete.

- 1 Click the **Start** button, point to **All Programs**—> **Accessories**—> **System Tools**, and then click **System Restore**.
- 2 Be sure **Restore my computer to an earlier time** is selected, and then click **Next**.
- 3 Click a calendar date to which you want to restore your computer.

The **Select a Restore Point** screen provides a calendar that allows you to see and select restore points. All calendar dates with available restore points appear in bold.

- 4 Select a restore point, and then click **Next**.

If a calendar date has only one restore point, then that restore point is automatically selected. If two or more restore points are available, click the restore point that you want to use.

➔ **NOTICE:** Save and close all open files and close all open programs. Do not alter, open, or delete any files or programs until the system restoration is complete.

- 5 Click **Next**.

The **Restoration Complete** screen appears after System Restore completes collecting data, and then the computer automatically restarts.

- 6 After the computer restarts, click **OK**.

To change the restore point, you can either repeat the steps using a different restore point, or you can undo the restoration.

## Undoing the Last System Restore

- ➡ **NOTICE:** Before undoing the last system restore, save and close all open files and close all open programs. Do not alter, open, or delete any files or programs until the system restoration is complete.
- 1 Click the **Start** button, point to **All Programs**—> **System Tools**, and then click **System Restore**.
  - 2 Select **Undo my last restoration** and click **Next**.
  - 3 Click **Next**.
  - 4 The **System Restore** screen appears, and then the computer automatically restarts.
  - 5 After the computer restarts, click **OK**.

## Reinstalling Windows XP

Before reinstalling the Windows XP operating system to correct a problem, try correcting the problem by performing a Windows XP System Restore (see page 49).

- ➡ **NOTICE:** The *Operating System* CD provides options for reinstalling your Windows XP operating system. The options can potentially overwrite files installed by Dell and possibly affect programs installed on your hard drive. Therefore, Dell does not recommend that you reinstall your operating system unless instructed to do so by a Dell technical support representative.
- ➡ **NOTICE:** To prevent conflicts with Windows XP, you must disable any virus protection software installed on your computer before you reinstall Windows XP.

 **HINT:** The CD that you need to place in your CD or DVD drive is titled *Operating System*.

- 1 Insert the *Operating System* CD into the CD or DVD drive.  
Close any program or utility that may start to run after you insert the CD into the drive.
- 2 Turn off the computer (see page 20), and then turn the computer on again.

- 3 When the blue Dell logo appears, press < F12> immediately.

If you wait too long and the operating system logo appears, continue to wait until you see the Microsoft Windows desktop. Then shut down the computer and try again.

- 4 Use the arrow keys to select the CD-ROM option, and then press < Enter> .

- 5 When the **Windows XP Setup** screen appears, press < Enter> to select **To set up Windows now**.

- 6 Read the information in the **License Agreement** window, and then press < F8> on your keyboard to agree with the license information.

- 7 If your computer already has Windows XP installed and you want to recover your current Windows XP data, type **R** to select the repair option, and then go to step 16.

If you want to install a new copy of Windows XP, press < Esc> to select the fresh copy option, and then press < Enter> on the next screen to select the highlighted partition (recommended). Then follow the instructions on the screen.

- 8 The **Windows XP Setup** screen appears and Windows XP begins to copy files and install the devices. The computer automatically restarts multiple times before it requires additional input.

- 9 When the **Welcome to Microsoft** screen appears, click the green arrow icon at the bottom of the screen to continue. Follow the on-screen directions to finish.

- 10 When the **Regional Settings** screen appears, select the settings for your locale, and then click **Next**.

- 11 Enter your name and organization in the **Personalize Your Software** screen, and then click **Next**.



- 12 If you are reinstalling Windows XP Home Edition, enter a name for your computer when the **Computer Name** window appears, and then click **Next**.

If you are reinstalling Windows XP Professional, enter a name for your computer and a password when the **Computer Name and Administrator Password** window appears, and then click **Next**.

- 13 If you have a modem installed, the **Modem Dialing Information** screen appears. Enter the requested information, and then click **Next**.

- 14 Enter the date, time, and time zone in the **Date and Time Settings** window, and then click **Next**.
- 15 If you have a network card in your computer, select the appropriate network settings. If you do not have a network card, you will not see this option.  
  
Windows XP begins to install its components and configure the computer. The computer automatically restarts.
- 16 When the **Welcome to Microsoft** screen appears, click the green arrow icon at the bottom of the screen to continue. Follow the on-screen directions to finish.
- 17 Remove the CD from the drive.
- 18 Reinstall the appropriate drivers (see page 45).
- 19 Reinstall your virus protection software.
- 20 Reinstall your other software programs. See the documentation that came with the software for instructions.

## Reinstalling Windows 2000

-  **NOTICE:** The *Operating System* CD provides options for reinstalling your Windows 2000 operating system. The options can potentially overwrite files installed by Dell and possibly affect programs installed on your hard drive. Therefore, Dell does not recommend that you reinstall your operating system unless instructed to do so by a Dell technical support representative.
-  **NOTICE:** To prevent conflicts with Windows 2000, you must disable any virus protection software installed on your computer before you reinstall Windows 2000.

 **HINT:** The CD that you need to place in your CD or DVD drive is titled *Operating System*.

- 1 Insert the *Operating System* CD into the CD or DVD drive.  
  
Close any program or utility that may start to run after you insert the CD into the drive.
- 2 Turn off the computer (see page 20), and then turn the computer on again.
- 3 When the blue Dell logo appears, press <F12> immediately.  
  
If you wait too long and the operating system logo appears, continue to wait until you see the Microsoft Windows desktop. Then shut down the computer and try again.

- 4 Use the arrow keys to select the CD-ROM option, and then press < Enter> .
- 5 When the **Windows 2000 Setup** screen appears, ensure that the **To setup Win2000 now, press ENTER** option is highlighted. Then press < Enter> .
- 6 Read the information in the **License Agreement** screen, and then press < F8> to continue.
- 7 When the **Windows 2000 Professional Setup** screen appears, use the arrow keys to select the Windows 2000 partition option that you want. To continue, press the key specified in the partition option that you chose.
- 8 When the **Windows 2000 Professional Setup** screen reappears, use the arrow keys to select the type of filing system that you want Windows 2000 to use, and then press < Enter> .
- 9 Press < Enter> again to restart your computer.
- 10 Click **Next** when the **Welcome to the Windows 2000 Setup Wizard** screen appears.
- 11 When the **Regional Settings** screen appears, select the settings for your locale, and then click **Next**.
- 12 Enter your name and organization in the **Personalize Your Software** screen, and then click **Next**.
- 13 Type the Windows product key in the fields provided, and then click **Next**.

The product key is the bar code number found on the Microsoft Windows label, which is located behind the front-panel connector door as shown on the *START HERE* sheet for your computer.

- 14 When the **Computer Name and Administrator Password** screen appears, enter a name for your computer and a password, if desired. Then click **Next**.
- 15 Enter the date and time in the **Date and Time Settings** screen, and then click **Next**.

Windows 2000 now begins to install its components and configure the computer.

- 16 When the **Completing the Windows 2000 Setup Wizard** screen appears, remove the CD from the drive, and then click **Finish**.  
The computer automatically restarts.



## SECTION 3

# Adding Parts

---

Front and Back View of the Computer

Removing the Computer Cover

Rotating the Power Supply

Looking Inside Your Computer

Adding a 3.5-Inch Drive

Adding Cards

Adding Memory

Replacing the Computer Cover

## Front and Back View of the Computer

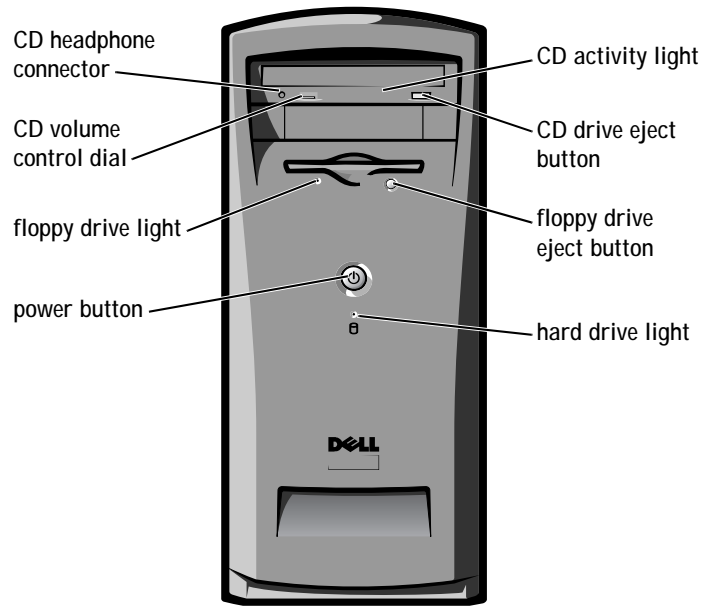

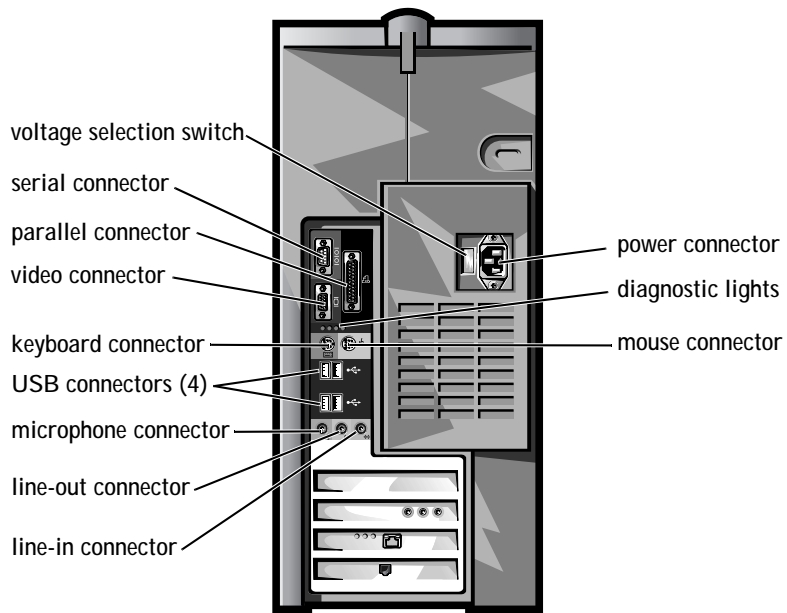

## Removing the Computer Cover

 **CAUTION:** Before you begin any of the procedures in this section, follow the safety instructions on page 9.

 **CAUTION:** To guard against electrical shock, always unplug your computer from the electrical outlet before opening the cover.

- 1 Shut down the computer (see page 20).
  - 2 Turn off any attached devices and disconnect them from their electrical outlets.
-  **NOTICE:** To disconnect a network cable, first unplug the cable from your computer and then unplug it from the network wall jack.
- 3 Disconnect the computer power cable from the wall outlet, and then press the power button to ground the system board.

- 4 Face the front of the computer. Place your left hand on the left side of the computer. Push back the release latch at the top-back edge of the computer to release the computer cover into your left hand.

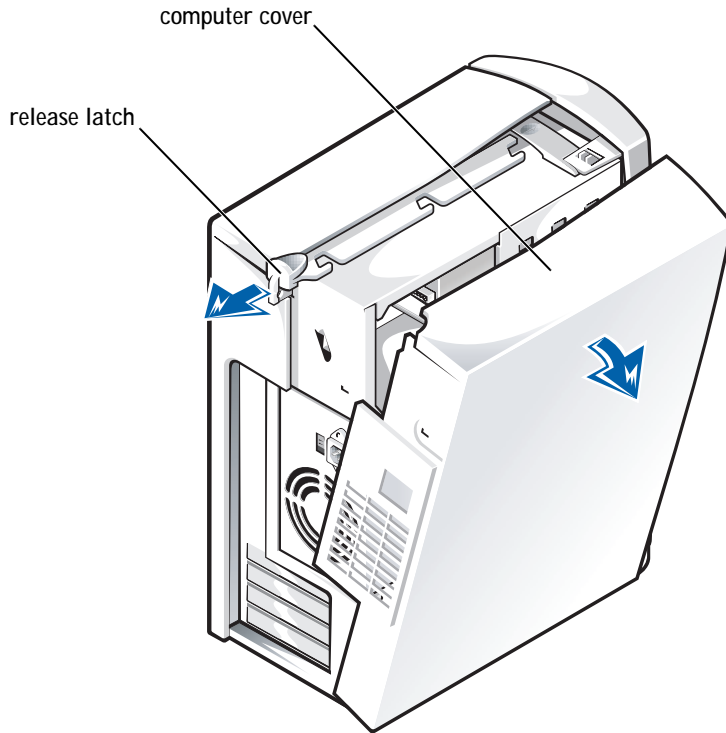

**⚠ CAUTION:** Keep your hands clear of the metal edges on the computer.

- 5 Lift the cover out from the curved hinge at the bottom of the computer.

## Rotating the Power Supply

 **CAUTION:** Before you begin any of the procedures in this section, follow the safety instructions on page 9.

 **CAUTION:** To guard against electrical shock, always unplug your computer from the electrical outlet before opening the cover.

To access components on the system board or to add parts to the computer, you must rotate the power supply out of the way:

- 1 Shut down the computer (see page 20).
- 2 Turn off any attached devices and disconnect them from their electrical outlets.
-  **NOTICE:** To disconnect a network cable, first unplug the cable from your computer and then unplug it from the network wall jack.
- 3 Disconnect the computer power cable from the wall outlet, and then press the power button to ground the system board.
- 4 Remove the computer cover (see page 60).

- 5 Lay the computer on its side as shown in the following illustration. Press the release latch while lifting the power supply. Rotate the power supply out of the computer while keeping the drive power cables clear.

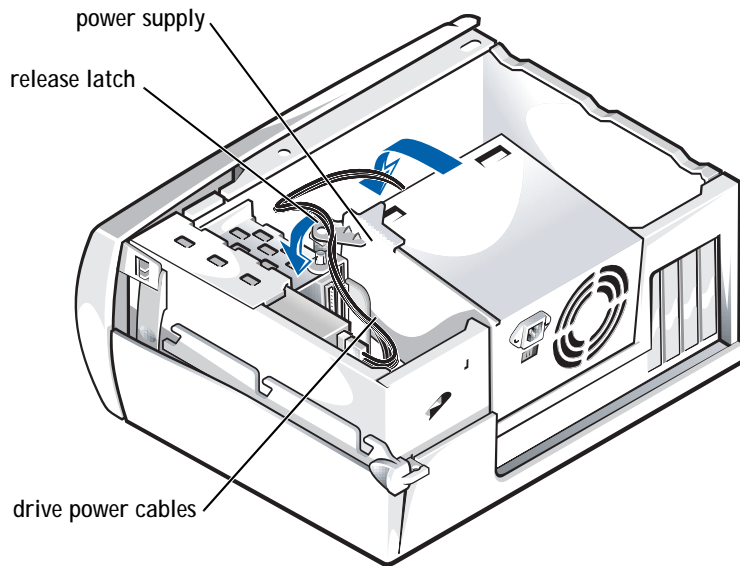

When you rotate the power supply back into the computer, gently lift the and hold the drive cables out of the way. Rotate the power supply into position until its release latch clicks. Lay the drive power cables along the top of the latch.

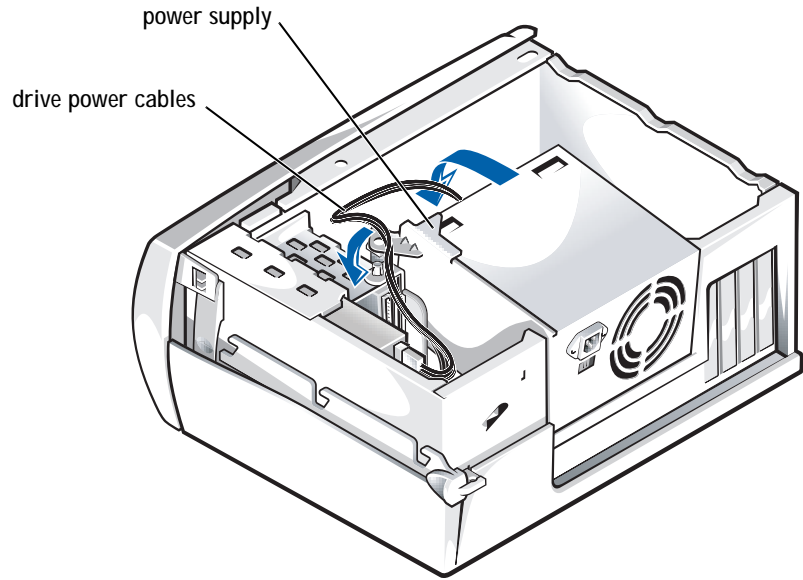



# Looking Inside Your Computer

**⚠ CAUTION:** Before you begin any of the procedures in this section, follow the safety instructions on page 9.

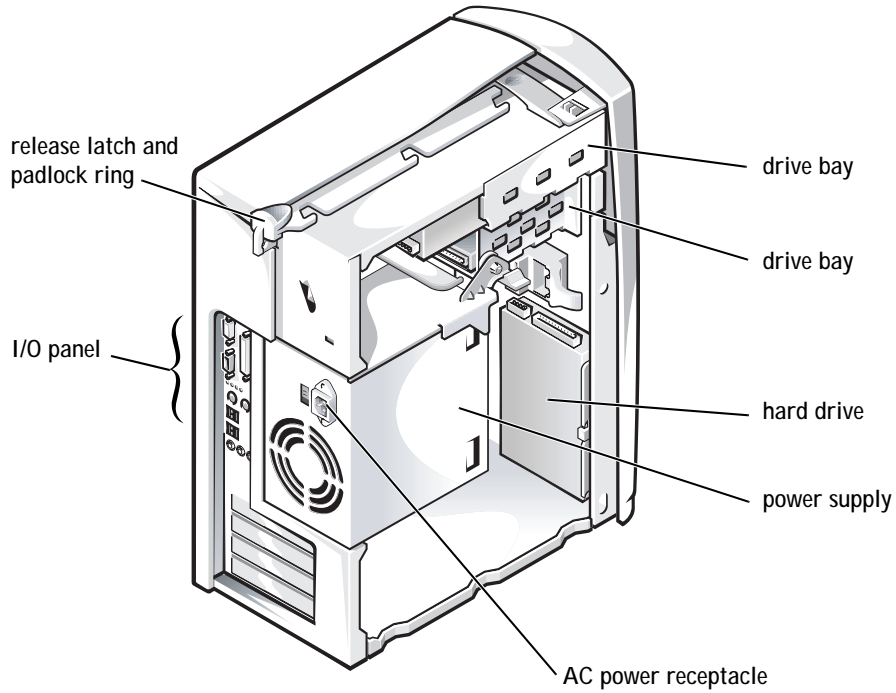

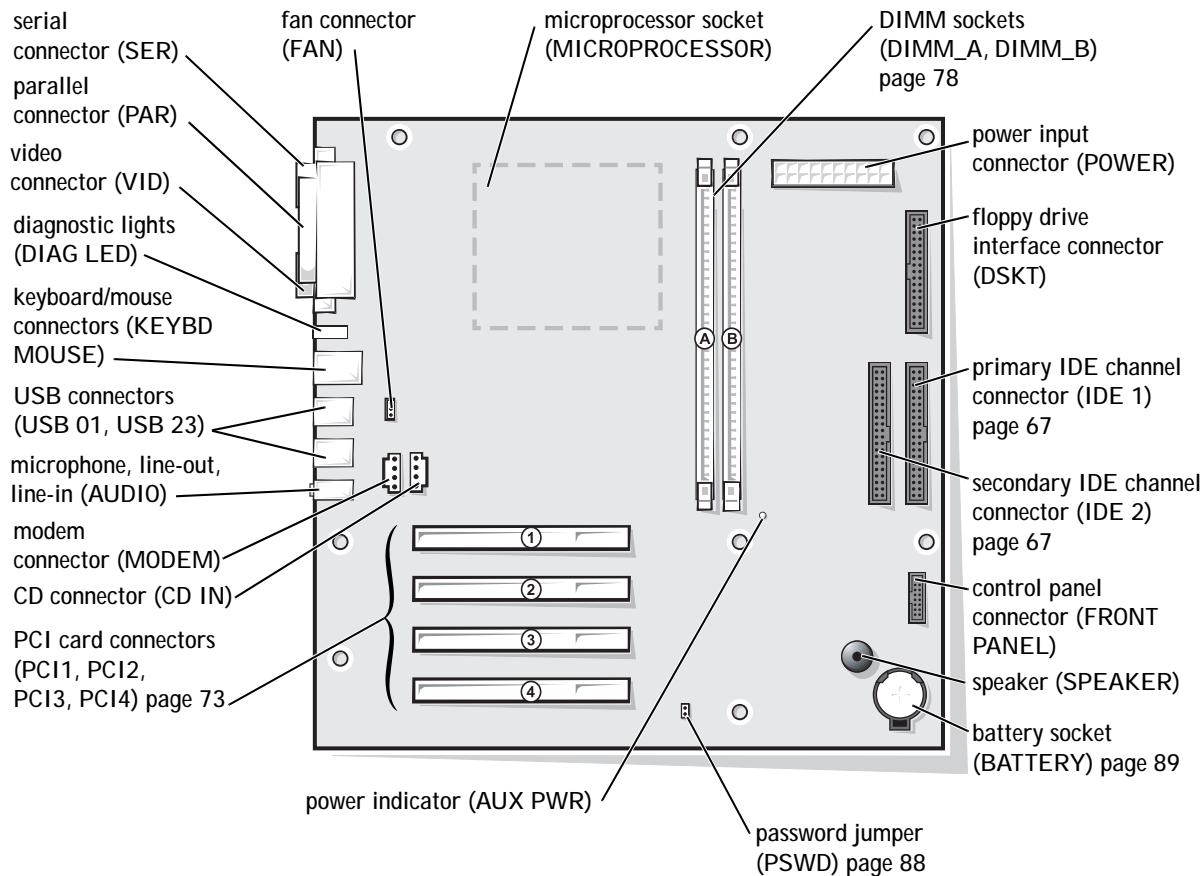

## System Board

In the illustration, the text in parentheses indicates how items are identified on the system board.



# Adding a 3.5-Inch Drive

 **CAUTION:** Before you begin any of the procedures in this section, follow the safety instructions on page 9.

 **CAUTION:** To guard against electrical shock, always unplug your computer from the electrical outlet before opening the cover.

Your computer includes one 3.5-inch drive. To add a second 3.5-inch drive:

- 1 Shut down the computer (see page 20).
- 2 Turn off any attached devices and disconnect them from their electrical outlets.
-  **NOTICE:** To disconnect a network cable, first unplug the cable from your computer and then unplug it from the network wall jack.
- 3 Disconnect the computer power cable from the wall outlet, and then press the power button to ground the system board.
- 4 Remove the computer cover (see page 60).

- 5 While facing the front of the computer, press the front-panel release tab on the top of the computer.

Swing the front panel away from the computer, disengage the two retaining hooks on the front panel, and carefully pull it away from the computer.

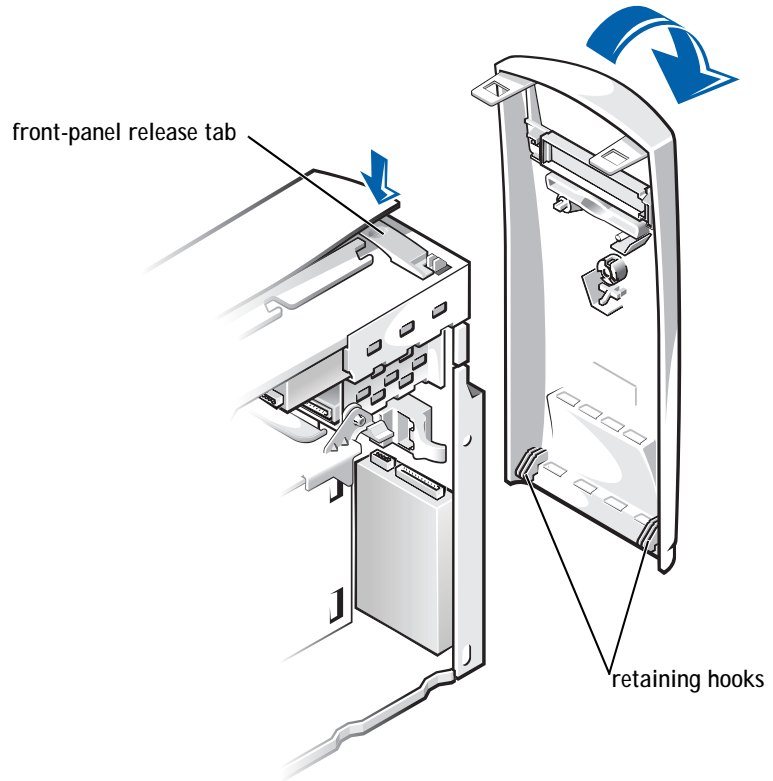

**6 Remove the front-panel insert.**

From the back of the front panel, press the release tab to the side. Then rotate the insert toward you, and remove it from the front panel.

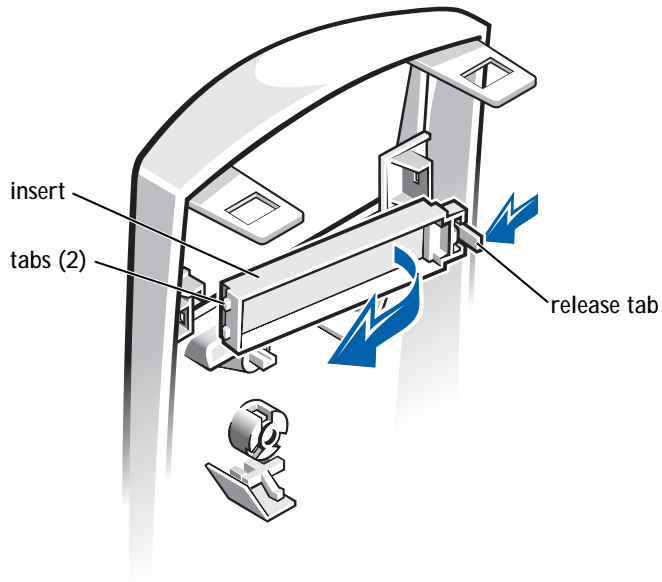

**7 Rotate the power supply (see page 62).**

- 8 Remove the metal drive bay plate covering the bay.

Using a screwdriver, pop out the metal plate from the left or right side of the computer.

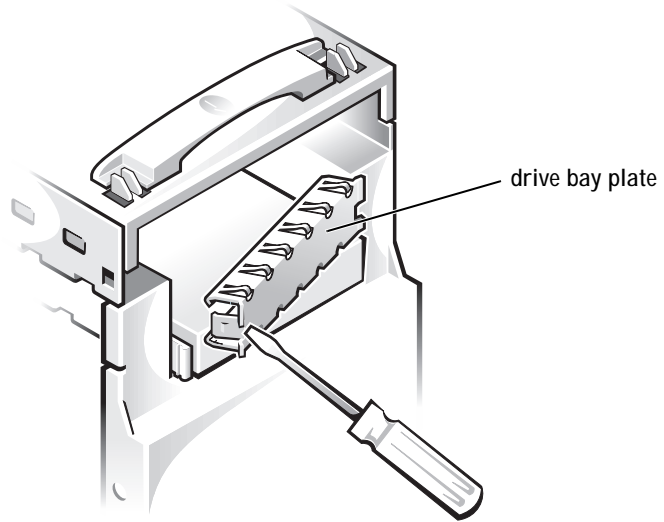

- 9 Remove the extra rails from the front of the computer frame (see the illustration below).

Install the rail marked "L" on the left side of the drive and the rail marked "R" on the right side of the drive.

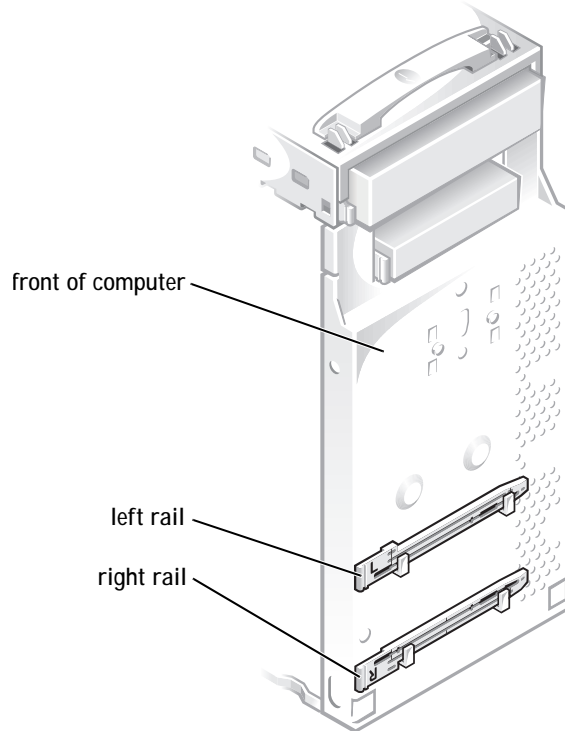

- 10 Slide the drive assembly into the drive bay.

**NOTICE:** Dell does not recommend routing cables over cards because the cables can restrict airflow, cause cooling problems, and interfere with removing and replacing the computer cover. If you must route cables over cards, be extremely cautious when removing and replacing the computer cover.

- 11 If you are installing a controller card, configure and install it in a connector slot now (see page 73 for instructions).

Install the card as close as you can to the drive cage.

- 12 Connect a power cable to the drive.

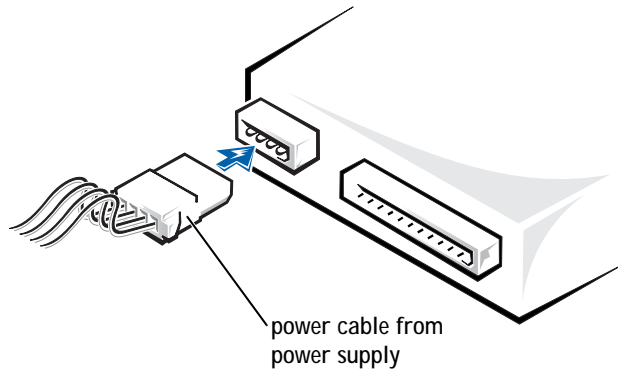

**NOTICE:** When you attach the extra connector to the new drive in the following step, match the colored strip on the cable with pin 1 on the drive.

- 13 If you didn't install a controller card in step 11, remove the tape from the wide cable connector and reattach the connector to the original drive. Then locate the extra connector on the cable and attach it to the new drive. Be sure that the wide cable is properly connected to the IDE connector on the system board.

If you installed a controller card in step 11, attach the other end of the interface cable to the controller card rather than to the system board.

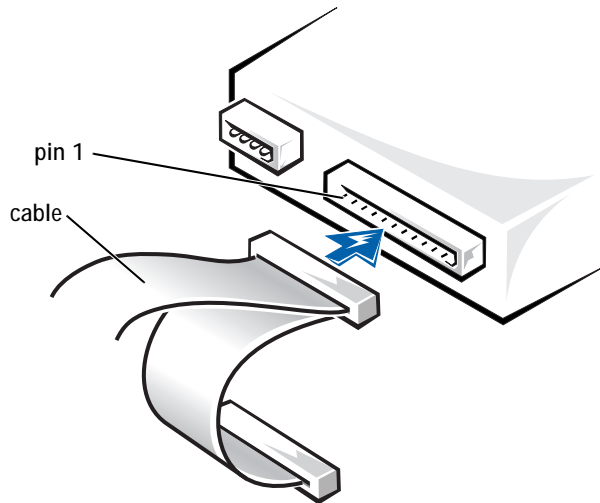



- 14 Replace the front panel.  
Fit the front panel's two retaining hooks into their corresponding slots on the computer (see page 68). Then, rotate the front panel toward the computer until the front panel latches into position.
- 15 Make sure that no cable connections were loosened during the procedure. Arrange cables so that they will not interfere with replacing the power supply and computer cover.
- 16 Rotate the power supply back into place (see page 64).
- 17 Replace the computer cover (see page 80).
- 18 Plug your computer and devices into their electrical outlets, and turn them on.
- 19 See the drive's documentation for instructions on installing any software required for drive operation.

## Adding Cards



**CAUTION:** Before you begin any of the procedures in this section, follow the safety instructions on page 9.



**CAUTION:** To guard against electrical shock, always unplug your computer from the electrical outlet before opening the cover.

- 1 Shut down the computer (see page 20).
  - 2 Turn off any attached devices and disconnect them from their electrical outlets.
-  **NOTICE:** To disconnect a network cable, first unplug the cable from your computer and then unplug it from the network wall jack.
- 3 Disconnect the computer power cable from the wall outlet, and then press the power button to ground the system board.
  - 4 Remove the computer cover (see page 60).
  - 5 Rotate the power supply (see page 62).

- 6 Unscrew and remove the filler bracket for the card slot you want to use.

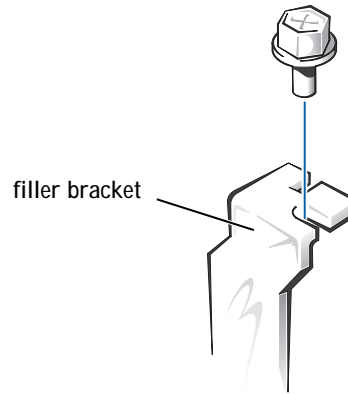

- 7 Align the cutout on the bottom of the card with the crossbar in the system board connector. Gently rock the card into the connector until it is fully seated.

If the card is full-length, insert the front end of the card into the corresponding card guide at the front of the computer as you insert the card into its connector.

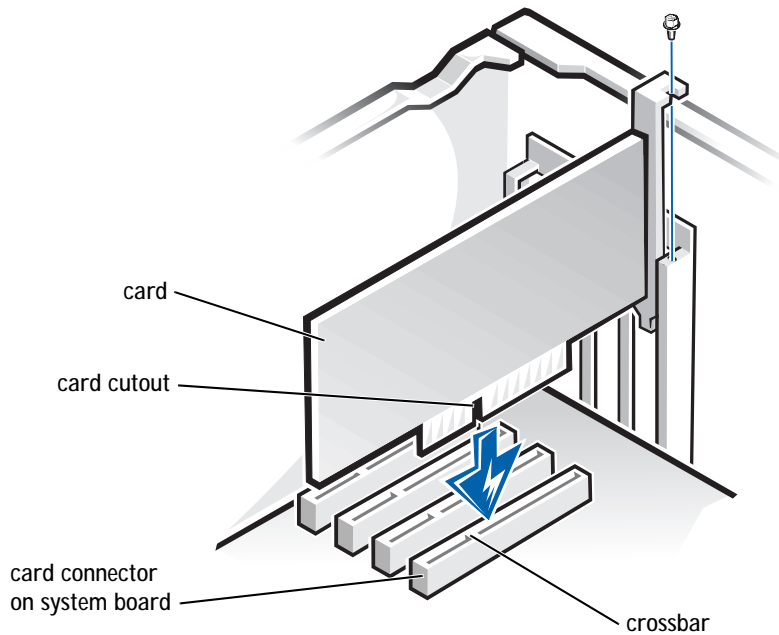

Make sure that the card is fully seated and that its bracket is within the card slot.

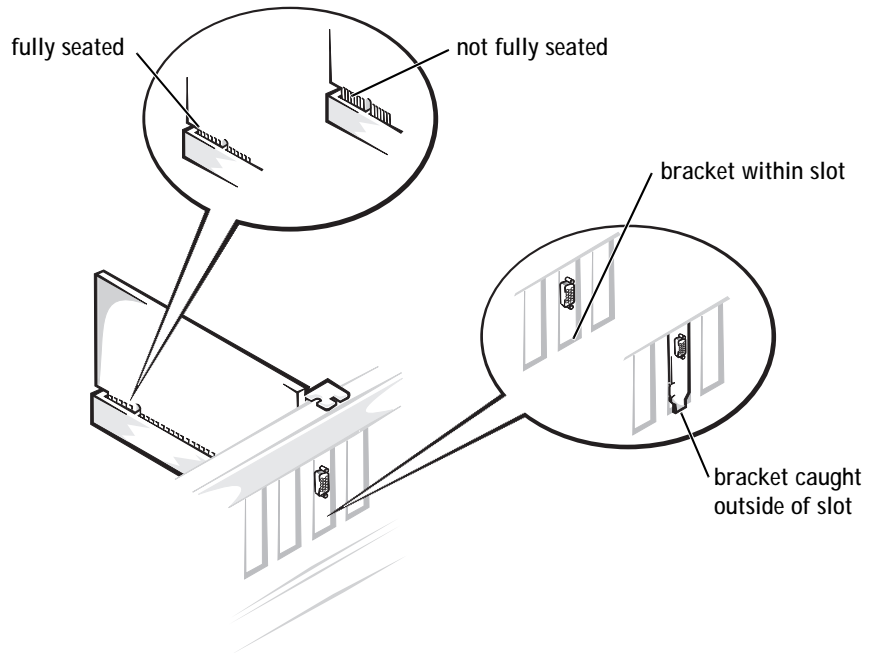

- 8 Secure the bracket on the end of the card with the screw you removed in step 6.
- 9 Connect any cables required for the card as described in the card documentation.
- 10 Rotate the power supply back into place (see page 64).
- 11 Replace the computer cover (see page 80).
- 12 Plug your computer and devices into their electrical outlets, and turn them on.
- 13 Install any drivers required for the card as described in the card documentation.

## Removing Cards



**CAUTION:** Before you begin any of the procedures in this section, follow the safety instructions on page 9.



**CAUTION:** To guard against electrical shock, always unplug your computer from the electrical outlet before opening the cover.

- 1 Shut down the computer (see page 20).
- 2 Turn off any attached devices and disconnect them from their electrical outlets.
-  **NOTICE:** To disconnect a network cable, first unplug the cable from your computer and then unplug it from the network wall jack.
- 3 Disconnect the computer power cable from the wall outlet, and then press the power button to ground the system board.
- 4 Remove the computer cover (see page 60).
- 5 Rotate the power supply (see page 62).
- 6 Disconnect any cables connected to the card.
- 7 Remove the screw from the card bracket.
- 8 Grasp the card by its top corners, and lift it from the system board.
- 9 If you are removing the card permanently, reinstall a filler bracket.
- 10 Rotate the power supply back into place (see page 64).
- 11 Replace the computer cover (see page 80).
- 12 Plug your computer and devices into their electrical outlets, and turn them on.



**HINT:** Memory purchased from Dell is covered under your computer warranty.

## Adding Memory

 **CAUTION:** Before you begin any of the procedures in this section, follow the safety instructions on page 9.

 **CAUTION:** To guard against electrical shock, always unplug your computer from the electrical outlet before opening the cover.

You can increase your computer memory by installing memory modules on the system board. See page 82 for information on the type of memory supported by your computer.

- 1 Shut down the computer (see page 20).
- 2 Turn off any attached devices and disconnect them from their electrical outlets.
-  **NOTICE:** To disconnect a network cable, first unplug the cable from your computer and then unplug it from the network wall jack.
- 3 Disconnect the computer power cable from the wall outlet, and then press the power button to ground the system board.
- 4 Open the computer cover (see page 60).
- 5 Rotate the power supply (see page 62).
- 6 If necessary, remove a memory module:
  - a Press out the securing clip at each end of the memory connector.
  - b Grasp the module and pull up.

If the module is difficult to remove, gently ease the module back and forth to remove it from the connector.

- 7 To insert a module, press out the securing clip at each end of the memory connector.

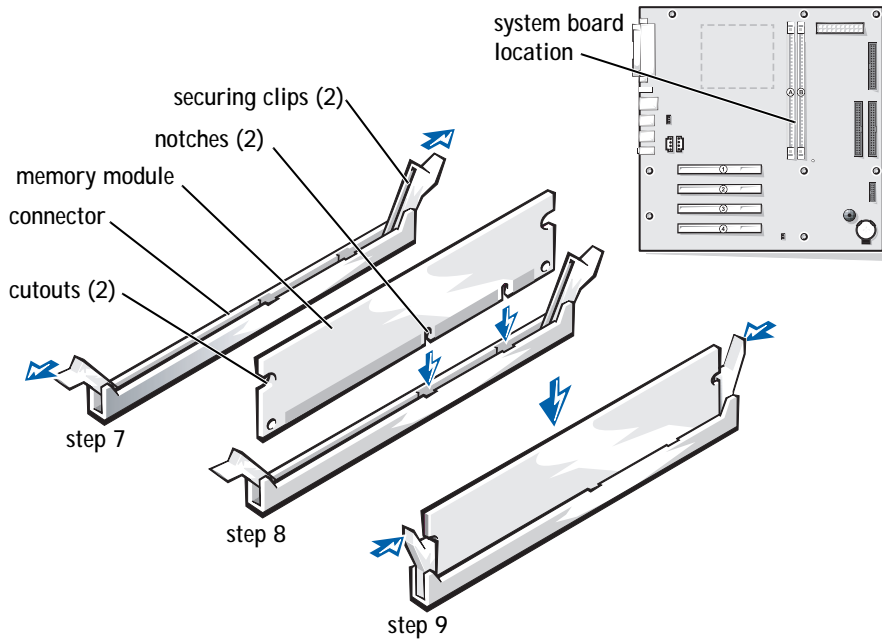

- 8 Align the notches on the bottom of the module with the crossbars in the connector.

**NOTICE:** To avoid breaking the memory module, do not press near the middle of the module.

- 9 Insert the module straight down into the connector, making sure that it fits into the vertical guides at each end of the connector.

Press firmly on the ends of the module until it snaps into place.

If you insert the module correctly, the securing clips snap into the cutouts at each end of the module.

 **HINT:** The system memory value reported by the operating system is 1 or 2 MB less than the memory installed because that memory is reserved for video functions.

- 10 Rotate the power supply back into place (see page 64).
- 11 Replace the computer cover (see the following section).

## Replacing the Computer Cover

- 1 Rotate the power supply back into place (see page 64).
- 2 Check all cable connections, especially those that might have come loose during your work. Fold cables and unused connectors out of the way so that they do not catch on the computer cover or interfere with airflow inside the computer.
- 3 Check to see that no tools or extra parts (including screws) are left inside the computer.
- 4 Place the computer upright with the front facing you. Align the computer cover so its bottom hooks fit in the computer's curved hinge.
- 5 Lift up the cover, making sure to keep the bottom hooks aligned with the curves in the computer.
- 6 Gently squeeze the right and left sides of the computer together until the cover clicks into position.



SECTION 4

## Appendix

- Specifications
- Standard Settings
- Clearing Forgotten Passwords
- Replacing the Battery
- Dell Technical Support Policy (U.S. Only)
- Contacting Dell
- Regulatory Information
- Limited Warranties and Return Policy

# Specifications

---

## Microprocessor

---

Microprocessor type	Intel® Celeron® microprocessor
L1 cache	32 KB (16-KB data cache; 16-KB instruction cache)
L2 cache	256-KB SRAM that resides in the processor's core. The L2 cache runs at the processor's internal clock speed

---

## System Information

---

System chip set	Intel 810E
DMA channels	two
Interrupt levels	24 APIC mode
System BIOS chip	4 Mb (512 KB)

---

## Expansion Bus

---

Bus types	PCI (version 2.2)
Bus speed	PCI: 33 MHz
PCI connectors	supports four three-quarter-length cards
PCI connector size	120 pins
PCI connector data width (maximum)	32 bits

---

## Memory

---

Architecture	non-ECC SDRAM modules
Memory connectors	two; gold contacts
Memory capacities	128, 256, and 512 MB (non-ECC)
Minimum memory	128 MB (non-ECC)
Maximum memory	512 MB (non-ECC)
Frequency	100 MHz
Voltage	3.3 V
Data bus width	64 bits

---

<b>Drives</b>	
Externally accessible	one 5.25-inch bay two 3.5-inch bays
Internally accessible	one bay for 1-inch-high IDE hard drive
Available devices	ATA-66 Ultra DMA hard drive, CD drive, DVD drive, and CD-RW drive

---

### Ports and Connectors

---

#### Externally accessible:

Serial	9-pin connector; 16550C-compatible
Parallel	25-hole connector (bidirectional)
Video	15-hole connector
Keyboard	6-pin mini-DIN connector or USB connector
Mouse	6-pin mini-DIN connector or USB connector
USB	four USB-compliant connectors
Audio <sup>1</sup>	three miniature connectors for line-in, line-out, and microphone

#### Internally accessible:

Primary EIDE channel	40-pin connector on PCI local bus
Secondary EIDE channel	40-pin connector on PCI local bus
Floppy drive	34-pin connector

---

### Video

---

Video controller	Intel 3D AGP graphics
------------------	-----------------------

---

### Audio<sup>2</sup>

---

Audio controller	ADI 1885
------------------	----------

---

<sup>1</sup> Present only on computers with built-in audio capabilities.

<sup>2</sup> Present only on computers with built-in audio capabilities.

---

**Controls and Lights**

---

Power control	push button
Power light	green
Hard-drive access light	green
Diagnostic code lights	four bicolor (amber and green) located on back panel

---

**Power**

---

**DC power supply:**

Wattage	145 W
Heat dissipation	495 BTU (fully loaded computer without monitor)
Voltage (switch-selectable on back panel)	90 to 135 V at 60 Hz; 180 to 265 V at 50 Hz; 100 V at 50 to 60 Hz for Japanese computers
Backup battery	3-V CR2032 coin cell

---

**Physical**

---

Height x Width x Depth	39 x 16.8 x 34 cm (15.375 x 6.625 x 13.375 inches)
Weight	9.9 Kg (22 lbs)

---

**Environmental**

---

**Temperature:**

Operating	10° to 35°C (50° to 95°F) <sup>3</sup>
Storage	-40° to 65°C (-40° to 149°F)

---

<sup>3</sup>At 35°C (95°F), the maximum operating altitude is 914 m (3000 ft).

---

**Environmental** *(continued)*

---

Relative humidity	20% to 80% (noncondensing)
Maximum vibration:	
Operating	0.25 G at 3 to 200 Hz at 1/2 octave/min
Storage	0.5 G at 3 to 200 Hz at 1/2 octave/min
Maximum shock:	
Operating	bottom half-sine pulse with a change in velocity of 50.8 cm/sec (20 inches/sec)
Storage	23-G faired-square wave with a velocity change of 508 cm/sec (200 inches/sec)
Altitude:	
Operating	-15.2 to 3048 m (-50 to 10,000 ft) <sup>4</sup>
Storage	-15.2 to 10,600 m (-50 to 35,000 ft)

---

<sup>4</sup>At 35°C (95°F), the maximum operating altitude is 914 m (3000 ft).

## Standard Settings

The system setup program contains the standard settings for your computer.

- ➔ **NOTICE:** Unless you are an expert computer user, don't change the settings for this program. Certain changes might make your computer work incorrectly.

See the following figure for an example of the main program screen.

Dell - Dimension 2200			
Intel® Celeron™ Processor: 1.20 GHz		BIOS Version: xxx	
Level 2 Cache: 256 KB Integrated		Service Tag: xxxxxx	
<pre> System Time .....00:00:00 System Date .....DY/MO/DATE/YR  Diskette Drive A: .....3.5 inch, 1.44 MB  Primary Drive 0 .....Hard Drive Primary Drive 1 .....Off Secondary Drive 0 .....CD-ROM Reader Secondary Drive 1 .....Off  Boot Sequence .....&lt;Enter&gt;  Memory Information .....&lt;Enter&gt; CPU Information .....&lt;Enter&gt;  Integrated Devices (LegacySelect Options) .....&lt;Enter&gt; PCI IRQ Assignments .....&lt;Enter&gt; IRQ Reservations .....&lt;Enter&gt; System Security .....&lt;Enter&gt;  Keyboard NumLock .....On Report Keyboard Errors .....Report  Auto Power On .....Disabled Remote Wake Up .....Off AC Power Recovery .....Last Fast Boot .....On Suspend Mode .....S3  System Event Log .....&lt;Enter&gt;  Asset Tag .....xxxxxx </pre>			
↓↑ to select	SPACE, +, - to change	ESC to exit	F1 = Help

## Viewing Settings

- 1 Turn on (or restart) your computer.
- 2 When the blue Dell™ logo appears, press < F2 > immediately.

If you wait too long and the operating system logo appears, continue to wait until you see the Microsoft® Windows desktop. Then shut down your computer and try again.

## System Setup Program Screens

The system setup program screens display the current configuration information for your computer. Information on the screen is divided into five areas:

- Title – The area at the top of all system setup screens that displays your computer's model number.
- Computer data – Two boxes below the title that display the system processor, L2 cache, service tag, and the version number of the BIOS.
- Options – A scrollable box listing options that define the configuration of your computer (including installed hardware, power conservation, and security features).

Fields to the right of the listed options contain settings or values. The settings and values that you can change are brighter on the screen. All other settings and values are set by the computer and cannot be changed. When < Enter > appears to the right of an option, press < Enter > to access a pop-up menu of additional options.

- Key functions – A line of boxes across the bottom of all system setup screens that lists keys and their functions within the system setup program.
- Help – Press < F1 > for information on the option that is selected (highlighted).

## Clearing Forgotten Passwords

 **CAUTION:** Before you begin this procedure, follow the safety instructions listed in "When Working Inside Your Computer" on page 11.

If you forget your user or setup password, you cannot operate your computer or change settings in the system setup program until you clear the forgotten password(s).

 **NOTICE:** This process erases both the system and setup passwords.

- 1 Shut down the computer (see page 20).
- 2 Turn off any attached devices and disconnect them from their electrical outlets.

 **NOTICE:** To disconnect a network cable, first unplug the cable from your computer and then unplug it from the network wall jack.

- 3 Disconnect the computer power cable from the wall outlet, and then press the power button to ground the system board.
- 4 Remove the computer cover (see page 60).
- 5 Locate jumper PSWD on the system board (see page 66) and remove the jumper plug.
- 6 Replace the computer cover (see page 80), plug your computer into an electrical outlet, and turn on the computer.

The existing password(s) are erased.

- 7 Shut down the computer (see page 20).
- 8 Turn off any attached devices and disconnect them from their electrical outlets.

 **NOTICE:** To disconnect a network cable, first unplug the cable from your computer and then unplug it from the network wall jack.

- 9 Disconnect the computer power cable from the wall outlet, and then press the power button to ground the system board.



- 10 Remove the computer cover (see page 60).
- 11 Reconnect the jumper plug to jumper PSWD (see page 66).
- 12 Replace the computer cover (see page 80), plug your computer into an electrical outlet, and turn on the computer.

Turning on your computer with the PSWD jumper installed reenables the password feature.

## Replacing the Battery

A coin-cell battery maintains computer configuration, date, and time information. The battery can last several years.

If you have to repeatedly reset time and date information after turning on the computer, replace the battery.



**CAUTION:** A new battery can explode if it is incorrectly installed. Replace the 3-V CR2032 battery only with the same or equivalent type recommended by the manufacturer. Discard used batteries according to the manufacturer's instructions (see page 14).

- 1 Record all the screens in the system setup program so that you can restore the correct settings in step 8 (see page 86).
- 2 Remove the computer cover (see page 60).
- 3 Rotate the power supply (see page 62).



**NOTICE:** To avoid damage to the system board while you pry the battery loose, be sure to insert the plastic screwdriver between the battery and the socket (not the system board).

- 4 Locate the battery socket BATTERY (see page 66) and pry the battery out of its socket with your fingers or with a plastic screwdriver.

- 5 Insert the battery into the socket with the side labeled "+" facing up.

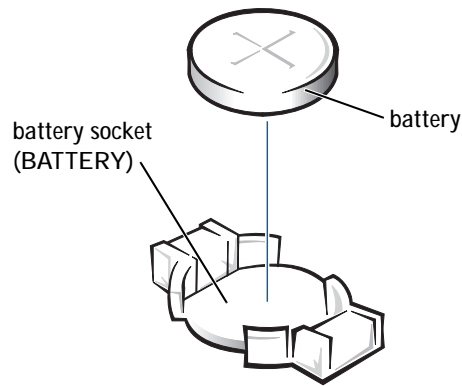

- 6 Rotate the power supply back into place (see page 64).
- 7 Replace the computer cover (see page 80), and plug your computer and devices into their electrical outlets.
- 8 Access the system setup program and restore the settings you recorded in step 1.

## Dell Technical Support Policy (U.S. Only)

Technician-assisted technical support requires the cooperation and participation of the customer in the troubleshooting process and provides for restoration of the operating system, application software, and hardware drivers to the original default configuration as shipped from Dell, as well as the verification of appropriate functionality of the computer and all Dell-installed hardware. In addition to this technician-assisted technical support, online technical support is available at [support.dell.com](http://support.dell.com). Additional technical support options may be available for purchase.

Dell provides limited technical support for the computer and any "Dell-installed" software and peripherals<sup>1</sup>. Support for third-party software and peripherals is provided by the original manufacturer, including those purchased and/or installed through Dell Software and Peripherals, Readyware, and Custom Factory Integration<sup>2</sup>.

<sup>1</sup> Repair services are provided pursuant to the terms and conditions of your limited warranty and any optional support service contract purchased with the computer.

<sup>2</sup> All Dell-standard components included in a Custom Factory Integration (CFI) project are covered by the standard Dell limited warranty for your computer. However, Dell also extends a parts replacement program to cover all nonstandard, third-party hardware components integrated through CFI for the duration of the computer's service contract.

### **Definition of "Dell-Installed" Software and Peripherals**

Dell-installed software includes the operating system and some of the application software that is preinstalled on the computer during the manufacturing process (Microsoft Office, Norton Antivirus, and so on).

Dell-installed peripherals include any internal expansion cards, or Dell-branded module bay or PC Card accessories. In addition, any Dell-branded monitors, keyboards, mice, speakers, microphones for telephonic modems, docking stations/port replicators, networking products, and all associated cabling are included.

### **Definition of "Third-Party" Software and Peripherals**

Third-party software and peripherals include any peripheral, accessory, or application software sold by Dell not under the Dell brand (printers, scanners, cameras, games, and so on). Support for all third-party software and peripherals is provided by the original manufacturer of the product.

 **HINT:** Toll-free numbers are for use within the country for which they are listed.

## Contacting Dell

When you need to contact Dell, use the telephone numbers, codes, and electronic addresses provided in the following tables. If you need assistance in determining which codes to use, contact a local or an international operator.

See "Dell Technical Support Policy" on page 90 for a description of the hardware and software support provided by Dell.

### Contact Numbers and Addresses

Country (City) International Access Code Country Code City Code	Department Name or Service Area, Website and E-Mail Address	Area Codes, Local Numbers, and Toll-Free Numbers
<b>Antigua and Barbuda</b>	General Support	1-800-805-5924
<b>Argentina (Buenos Aires)</b>	Tech Support and Customer Care	toll-free: 0-800-444-0733
International Access Code: 00	Sales	1-810-444-3355
Country Code: 54	Tech Support Fax	11 4515 7139
City Code: 11	Customer Care Fax	11 4515 7138
	Website: <a href="http://www.dell.com.ar">www.dell.com.ar</a>	
<b>Australia (Sydney)</b>	Home and Small Business	1-300-65-55-33
International Access Code: <b>0011</b>	Government and Business	toll-free: 1-800-633-559
Country Code: <b>61</b>	Preferred Accounts Division (PAD)	toll-free: 1-800-060-889
City Code: <b>2</b>	Customer Care	toll-free: 1-800-819-339
	Corporate Sales	toll-free: 1-800-808-385
	Transaction Sales	toll-free: 1-800-808-312
	Fax	toll-free: 1-800-818-341

Country (City) International Access Code Country Code City Code	Department Name or Service Area, Website and E-Mail Address	Area Codes, Local Numbers, and Toll-Free Numbers
<b>Austria (Vienna)</b>	Home/Small Business Sales	01 795 67602
International Access Code: <b>900</b>	Home/Small Business Fax	01 795 67605
Country Code: <b>43</b>	Home/Small Business Customer Care	01 795 67603
City Code: <b>1</b>	Preferred Accounts/Corporate Customer Care	0660 8056
	Home/Small Business Technical Support	01 795 67604
	Preferred Accounts/Corporate Technical Support	0660 8779
	Switchboard	01 491 04 0
	Website: <b>support.euro.dell.com</b>	
	E-mail: tech_support_central_europe@dell.com	
<b>Barbados</b>	General Support	1-800-534-3066
<b>Belgium (Brussels)</b>	Technical Support	02 481 92 88
International Access Code: <b>00</b>	Customer Care	02 481 91 19
Country Code: <b>32</b>	Home/Small Business Sales	toll-free: 0800 16884
City Code: <b>2</b>	Corporate Sales	02 481 91 00
	Fax	02 481 92 99
	Switchboard	02 481 91 00
	Website: <b>support.euro.dell.com</b>	
	E-mail: tech_be@dell.com	
	E-mail for French Speaking Customers: support.euro.dell.com/be/fr/emaildell/	
<b>Bermuda</b>	General Support	1-800-342-0671
<b>Brazil</b>	Customer Support, Technical Support	0800 90 3355
International Access Code: <b>00</b>	Tech Support Fax	51 481 5470
Country Code: <b>55</b>	Customer Care Fax	51 481 5480
City Code: <b>51</b>	Sales	0800 90 3390
	Website: <b>www.dell.com/br</b>	
<b>Brunei</b>	Customer Technical Support (Penang, Malaysia)	604 633 4966
Country Code: <b>673</b>	Customer Service (Penang, Malaysia)	604 633 4949
	Transaction Sales (Penang, Malaysia)	604 633 4955

<b>Country (City) International Access Code Country Code City Code</b>	<b>Department Name or Service Area, Website and E-Mail Address</b>	<b>Area Codes, Local Numbers, and Toll-Free Numbers</b>
<b>Canada (North York, Ontario)</b> International Access Code: <b>011</b>	Automated Order-Status System AutoTech (Automated technical support) Customer Care (From outside Toronto) Customer Care (From within Toronto) Customer Technical Support Sales (Direct sales—from outside Toronto) Sales (Direct sales—from within Toronto) Sales (Federal government, education, and medical) Sales (Major accounts) TechFax	toll-free: 1-800-433-9014 toll-free: 1-800-247-9362 toll-free: 1-800-387-5759 416 758-2400 toll-free: 1-800-847-4096 toll-free: 1-800-387-5752 416 758-2200 toll-free: 1-800-567-7542 toll-free: 1-800-387-5755 toll-free: 1-800-950-1329
<b>Cayman Islands</b>	General Support	1-800-805-7541
<b>Chile (Santiago)</b> Country Code: <b>56</b> City Code: <b>2</b>	Sales, Customer Support, and Technical Support	toll-free: 1230-020-4823
<b>China (Xiamen)</b> Country Code: <b>86</b> City Code: <b>592</b>	Home and Small Business Technical Support Corporate Accounts Technical Support Customer Experience Home and Small Business Preferred Accounts Division Large Corporate Accounts North Large Corporate Accounts East Large Corporate Accounts South Large Corporate Accounts GCP Large Corporate Accounts HK Large Corporate Accounts GCP HK	toll-free: 800 858 2437 toll-free: 800 858 2333 toll-free: 800 858 2060 toll-free: 800 858 2222 toll-free: 800 858 2062 toll-free: 800 858 2999 toll-free: 800 858 2020 toll-free: 800 858 2355 toll-free: 800 858 2055 toll-free: 800 964108 toll-free: 800 907308
<b>Colombia</b>	General Support	980-9-15-3978
<b>Costa Rica</b>	General Support	0800-012-0435

Country (City) International Access Code Country Code City Code	Department Name or Service Area, Website and E-Mail Address	Area Codes, Local Numbers, and Toll-Free Numbers
<b>Czech Republic (Prague)</b>	Technical Support	02 22 83 27 27
International Access Code: <b>00</b>	Customer Care	02 22 83 27 11
Country Code: <b>420</b>	Fax	02 22 83 27 14
City Code: <b>2</b>	TechFax	02 22 83 27 28
	Switchboard	02 22 83 27 11
	Website: <b>support.euro.dell.com</b>	
	E-mail: <b>czech_dell@dell.com</b>	
<b>Denmark (Copenhagen)</b>	Technical Support	7023 0182
International Access Code: <b>00</b>	Customer Care (Relational)	7023 0184
Country Code: <b>45</b>	Home/Small Business Customer Care	3287 5505
	Switchboard (Relational)	3287 1200
	Fax Switchboard (Relational)	3287 1201
	Switchboard (Home/Small Business)	3287 5000
	Fax Switchboard (Home/Small Business)	3287 5001
	Website: <b>support.euro.dell.com</b>	
	E-mail Support (Portable Computers): den_nbk_support@dell.com	
	E-mail Support (Desktop Computers): den_support@dell.com	
	E-mail Support (Servers): Nordic_server_support@dell.com	
<b>Dominican Republic</b>	General Support	1-800-148-0530
<b>El Salvador</b>	General Support	01-899-753-0777

<b>Country (City) International Access Code Country Code City Code</b>	<b>Department Name or Service Area, Website and E-Mail Address</b>	<b>Area Codes, Local Numbers, and Toll-Free Numbers</b>
<b>Finland (Helsinki)</b>	Technical Support	09 253 313 60
International Access Code: <b>990</b>	Technical Support Fax	09 253 313 81
Country Code: <b>358</b>	Relational Customer Care	09 253 313 38
City Code: <b>9</b>	Home/Small Business Customer Care	09 693 791 94
	Fax	09 253 313 99
	Switchboard	09 253 313 00
	Website: <b>support.euro.dell.com</b>	
	E-mail: <a href="mailto:fin_support@dell.com">fin_support@dell.com</a>	
	E-mail Support (Servers): <a href="mailto:Nordic_support@dell.com">Nordic_support@dell.com</a>	
<b>France (Paris) (Montpellier)</b>	<b>Home and Small Business</b>	
International Access Code: <b>00</b>	Technical Support	0825 387 270
Country Code: <b>33</b>	Customer Care	0825 823 833
City Codes: <b>(1) (4)</b>	Switchboard	0825 004 700
	Switchboard (Calls from outside of France)	04 99 75 40 00
	Sales	0825 004 700
	Fax	0825 004 701
	Fax (Calls from outside of France)	04 99 75 40 01
	Website: <b>support.euro.dell.com</b>	
	E-mail: <a href="mailto:support.euro.dell.com/fr/fr/emaildell/">support.euro.dell.com/fr/fr/emaildell/</a>	
	<b>Corporate</b>	
	Technical Support	0825 004 719
	Customer Care	0825 338 339
	Switchboard	01 55 94 71 00
	Sales	01 55 94 71 00
	Fax	01 55 94 71 01
	Website: <b>support.euro.dell.com</b>	
	E-mail: <a href="mailto:support.euro.dell.com/fr/fr/emaildell/">support.euro.dell.com/fr/fr/emaildell/</a>	



<b>Country (City) International Access Code Country Code City Code</b>	<b>Department Name or Service Area, Website and E-Mail Address</b>	<b>Area Codes, Local Numbers, and Toll-Free Numbers</b>
<b>Germany (Langen)</b>	Technical Support	06103 766-7200
International Access Code: <b>00</b>	Home/Small Business Customer Care	0180-5-224400
Country Code: <b>49</b>	Global Segment Customer Care	06103 766-9570
City Code: <b>6103</b>	Preferred Accounts Customer Care	06103 766-9420
	Large Accounts Customer Care	06103 766-9560
	Public Accounts Customer Care	06103 766-9555
	Switchboard	06103 766-7000
	Website: <b>support.euro.dell.com</b>	
	E-mail: <b>tech_support_central_europe@dell.com</b>	
<b>Guatemala</b>	General Support	1-800-999-0136
<b>Hong Kong</b>	Technical Support	toll-free: 800 96 4107
International Access Code: <b>001</b>	Customer Service (Penang, Malaysia)	604 633 4949
Country Code: <b>852</b>	Transaction Sales	toll-free: 800 96 4109
	Corporate Sales	toll-free: 800 96 4108
<b>India</b>	Technical Support	1600 33 8045
	Sales	1600 33 8044

<b>Country (City) International Access Code Country Code City Code</b>	<b>Department Name or Service Area, Website and E-Mail Address</b>	<b>Area Codes, Local Numbers, and Toll-Free Numbers</b>
<b>Ireland (Cherrywood)</b>	Ireland Technical Support	1850 543 543
International Access Code: <b>16</b>	U.K. Technical Support (Dial number within U.K. only)	0870 908 0800
Country Code: <b>353</b>	Home User Customer Care	01 204 4095
City Code: <b>1</b>	Small Business Customer Care	01 204 4444
	U.K. Customer Care (Dial number within U.K. only)	0870 906 0010
	Corporate Customer Care	01 204 4003
	Ireland Sales	01 204 4444
	U.K. Sales (Dial number within U.K. only)	0870 907 4000
	SalesFax	01 204 0144
	Fax	01 204 5960
	Switchboard	01 204 4444
	Website: <b>support.euro.dell.com</b>	
	E-mail: <b>dell_direct_support@dell.com</b>	
<b>Italy (Milan)</b>	<b>Home and Small Business</b>	
International Access Code: <b>00</b>	Technical Support	02 577 826 90
Country Code: <b>39</b>	Customer Care	02 696 821 14
City Code: <b>02</b>	Fax	02 696 821 13
	Switchboard	02 696 821 12
	Website: <b>support.euro.dell.com</b>	
	E-mail: <b>support.euro.dell.com/it/it/emaildell/</b>	
	<b>Corporate</b>	
	Technical Support	02 577 826 90
	Customer Care	02 577 825 55
	Fax	02 575 035 30
	Switchboard	02 577 821
	Website: <b>support.euro.dell.com</b>	
	E-mail: <b>support.euro.dell.com/it/it/emaildell/</b>	
<b>Jamaica</b>	General Support	1-800-682-3639

<b>Country (City) International Access Code Country Code City Code</b>	<b>Department Name or Service Area, Website and E-Mail Address</b>	<b>Area Codes, Local Numbers, and Toll-Free Numbers</b>
<b>Japan (Kawasaki)</b> International Access Code: <b>001</b> Country Code: <b>81</b> City Code: <b>44</b>	Technical Support (Server)	toll-free: 0120-1984-35
	Technical Support Outside of Japan (Server)	81-44-556-4152
	Technical Support (Dimension™ and Inspiron™)	toll-free: 0120-1982-26
	Technical Support Outside of Japan (Dimension and Inspiron)	81-44-520-1435
	Technical Support (Dell Precision™, OptiPlex™, and Latitude™)	toll-free: 0120-1984-33
	Technical Support Outside of Japan (Dell Precision, OptiPlex, and Latitude)	81-44-556-3894
	24-Hour Automated Order Service	044 556-3801
	Customer Care	044 556-4240
	Business Sales Division (Up to 400 employees)	044 556-3494
	Preferred Accounts Division Sales (Over 400 employees)	044 556-3433
	Large Corporate Accounts Sales (Over 3500 employees)	044 556-3440
	Public Sales (Government agencies, educational institutions, and medical institutions)	044 556-3440
	Global Segment Japan	044 556-3469
	Individual User	044 556-1657
	Faxbox Service	044 556-3490
Switchboard	044 556-4300	
Website: <a href="http://support.jp.dell.com">support.jp.dell.com</a>		
<b>Korea (Seoul)</b> International Access Code: <b>001</b> Country Code: <b>82</b> City Code: <b>2</b>	Technical Support	toll-free: 080-200-3800
	Sales	toll-free: 080-200-3600
	Customer Service (Seoul, Korea)	toll-free: 080-200-3800
	Customer Service (Penang, Malaysia)	604 633 4949
	Fax	2194-6202
Switchboard	2194-6000	

Country (City) International Access Code Country Code City Code	Department Name or Service Area, Website and E-Mail Address	Area Codes, Local Numbers, and Toll-Free Numbers
<b>Latin America</b>	Customer Technical Support (Austin, Texas, U.S.A.)	512 728-4093
	Customer Service (Austin, Texas, U.S.A.)	512 728-3619
	Fax (Technical Support and Customer Service) (Austin, Texas, U.S.A.)	512 728-3883
	Sales (Austin, Texas, U.S.A.)	512 728-4397
	SalesFax (Austin, Texas, U.S.A.)	512 728-4600 or 512 728-3772
<b>Luxembourg</b> International Access Code: <b>00</b> Country Code: <b>352</b>	Technical Support (Brussels, Belgium)	02 481 92 88
	Home/Small Business Sales (Brussels, Belgium)	toll-free: 080016884
	Corporate Sales (Brussels, Belgium)	02 481 91 00
	Customer Care (Brussels, Belgium)	02 481 91 19
	Fax (Brussels, Belgium)	02 481 92 99
	Switchboard (Brussels, Belgium)	02 481 91 00
	Website: <b>support.euro.dell.com</b> E-mail: tech_be@dell.com	
<b>Macau</b> Country Code: <b>853</b>	Technical Support	toll-free: 0800 582
	Customer Service (Penang, Malaysia)	604 633 4949
	Transaction Sales	toll-free: 0800 581
<b>Malaysia (Penang)</b> International Access Code: <b>00</b> Country Code: <b>60</b> City Code: <b>4</b>	Technical Support	toll-free: 1 800 888 298
	Customer Service	04 633 4949
	Transaction Sales	toll-free: 1 800 888 202
	Corporate Sales	toll-free: 1 800 888 213

<b>Country (City) International Access Code Country Code City Code</b>	<b>Department Name or Service Area, Website and E-Mail Address</b>	<b>Area Codes, Local Numbers, and Toll-Free Numbers</b>
<b>Mexico</b>	Customer Technical Support	001-877-384-8979
International Access Code: <b>00</b>		or 001-877-269-3383
Country Code: <b>52</b>	Sales	50-81-8800
		or 01-800-888-3355
	Customer Service	001-877-384-8979
		or 001-877-269-3383
	Main	50-81-8800
		or 01-800-888-3355
<b>Netherlands Antilles</b>	General Support	001-800-882-1519
<b>Netherlands (Amsterdam)</b>	Technical Support	020 581 8838
International Access Code: <b>00</b>	Customer Care	020 581 8740
Country Code: <b>31</b>	Home/Small Business Sales	toll-free: 0800-0663
City Code: <b>20</b>	Home/Small Business Sales Fax	020 682 7171
	Corporate Sales	020 581 8818
	Corporate Sales Fax	020 686 8003
	Fax	020 686 8003
	Switchboard	020 581 8818
	Website: <b>support.euro.dell.com</b>	
	E-mail: <b>tech_nl@dell.com</b>	
<b>New Zealand</b>	Home and Small Business	0800 446 255
International Access Code: <b>00</b>	Government and Business	0800 444 617
Country Code: <b>64</b>	Sales	0800 441 567
	Fax	0800 441 566
<b>Nicaragua</b>	General Support	001-800-220-1006

<b>Country (City) International Access Code Country Code City Code</b>	<b>Department Name or Service Area, Website and E-Mail Address</b>	<b>Area Codes, Local Numbers, and Toll-Free Numbers</b>
<b>Norway (Lysaker)</b>	Technical Support	671 16882
International Access Code: <b>00</b>	Relational Customer Care	671 17514
Country Code: <b>47</b>	Home/Small Business Customer Care	23162298
	Switchboard	671 16800
	Fax Switchboard	671 16865
	Website: <b>support.euro.dell.com</b>	
	E-mail Support (Portable Computers): nor_nbk_support@dell.com	
	E-mail Support (Desktop Computers): nor_support@dell.com	
	E-mail Support (Servers): Nordic_server_support@dell.com	
<b>Panama</b>	General Support	001-800-507-0962
<b>Peru</b>	General Support	0800-50-669
<b>Poland (Warsaw)</b>	Customer Service Phone	57 95 700
International Access Code: <b>011</b>	Customer Care	57 95 999
Country Code: <b>48</b>	Sales	57 95 999
City Code: <b>22</b>	Customer Service Fax	57 95 806
	Reception Desk Fax	57 95 998
	Switchboard	57 95 999
	Website: <b>support.euro.dell.com</b>	
	E-mail: pl_support@dell.com	
<b>Portugal</b>	Technical Support	800 834 077
International Access Code: <b>00</b>	Customer Care	800 300 415 or 800 834 075
Country Code: <b>35</b>	Sales	800 300 410 or 800 300 411 or 800 300 412 or 121 422 07 10
	Fax	121 424 01 12
	E-mail: support.euro.dell.com/es/es/emaildell/	
<b>Puerto Rico</b>	General Support	1-800-805-7545

<b>Country (City) International Access Code Country Code City Code</b>	<b>Department Name or Service Area, Website and E-Mail Address</b>	<b>Area Codes, Local Numbers, and Toll-Free Numbers</b>
<b>St. Lucia</b>	General Support	1-800-882-1521
<b>Singapore (Singapore)</b>	Technical Support	toll-free: 800 6011 051
International Access Code: <b>005</b>	Customer Service (Penang, Malaysia)	604 633 4949
Country Code: <b>65</b>	Transaction Sales	toll-free: 800 6011 054
	Corporate Sales	toll-free: 800 6011 053
<b>South Africa (Johannesburg)</b>	Technical Support	011 709 7710
International Access Code:	Customer Care	011 709 7707
<b>09/091</b>	Sales	011 709 7700
Country Code: <b>27</b>	Fax	011 706 0495
City Code: <b>11</b>	Switchboard	011 709 7700
	Website: <b>support.euro.dell.com</b>	
	E-mail: <b>dell_za_support@dell.com</b>	
<b>Southeast Asian and Pacific Countries</b>	Customer Technical Support, Customer Service, and Sales (Penang, Malaysia)	604 633 4810
<b>Spain (Madrid)</b>	<b>Home and Small Business</b>	
International Access Code: <b>00</b>	Technical Support	902 100 130
Country Code: <b>34</b>	Customer Care	902 118 540
City Code: <b>91</b>	Sales	902 118 541
	Switchboard	902 118 541
	Fax	902 118 539
	Website: <b>support.euro.dell.com</b>	
	E-mail: <b>support.euro.dell.com/es/es/emaildell/</b>	
	<b>Corporate</b>	
	Technical Support	902 100 130
	Customer Care	902 118 546
	Switchboard	91 722 92 00
	Fax	91 722 95 83
	Website: <b>support.euro.dell.com</b>	
	E-mail: <b>support.euro.dell.com/es/es/emaildell/</b>	

Country (City) International Access Code Country Code City Code	Department Name or Service Area, Website and E-Mail Address	Area Codes, Local Numbers, and Toll-Free Numbers
<b>Sweden (Upplands Vasby)</b>	Technical Support	08 590 05 199
International Access Code: <b>00</b>	Relational Customer Care	08 590 05 642
Country Code: <b>46</b>	Home/Small Business Customer Care	08 587 70 527
City Code: <b>8</b>	Fax Technical Support	08 590 05 594
	Sales	08 590 05 185
	Website: <b>support.euro.dell.com</b>	
	E-mail: <b>swe_support@dell.com</b>	
	E-mail Support for Latitude and Inspiron: <b>Swe-nbk_kats@dell.com</b>	
	E-mail Support for OptiPlex: <b>Swe_kats@dell.com</b>	
	E-mail Support for Servers: <b>Nordic_server_support@dell.com</b>	
<b>Switzerland (Geneva)</b>	Technical Support (Home and Small Business)	0844 811 411
International Access Code: <b>00</b>	Technical Support (Corporate)	0844 822 844
Country Code: <b>41</b>	Customer Care (Home and Small Business)	0848 802 202
City Code: <b>22</b>	Customer Care (Corporate)	0848 821 721
	Fax	022 799 01 90
	Switchboard	022 799 01 01
	Website: <b>support.euro.dell.com</b>	
	E-mail: <b>swisstech@dell.com</b>	
	E-mail for French Speaking HSB and Corporate Customers: <b>support.euro.dell.com/ch/fr/emaildell/</b>	
<b>Taiwan</b>	Technical Support	toll-free: 0080 60 1255
International Access Code: <b>002</b>	Technical Support (Servers)	toll-free: 0080 60 1256
Country Code: <b>886</b>	Transaction Sales	toll-free: 0080 651 228 or 0800 33 556
	Corporate Sales	toll-free: 0080 651 227 or 0800 33 555
<b>Thailand</b>	Technical Support	toll-free: 0880 060 07
International Access Code: <b>001</b>	Customer Service (Penang, Malaysia)	604 633 4949
Country Code: <b>66</b>	Sales	toll-free: 0880 060 09



Country (City) International Access Code Country Code City Code	Department Name or Service Area, Website and E-Mail Address	Area Codes, Local Numbers, and Toll-Free Numbers
<b>Trinidad/Tobago</b>	General Support	1-800-805-8035
<b>U.K. (Bracknell)</b>	Technical Support (Corporate/Preferred Accounts/PAD [1000+ employees])	0870 908 0500
International Access Code: <b>00</b>	Technical Support (Direct/PAD and general)	0870 908 0800
Country Code: <b>44</b>	Global Accounts Customer Care	01344 373 185 or 01344 373 186
City Code: <b>1344</b>	Home and Small Business Customer Care	0870 906 0010
	Corporate Customer Care	0870 908 0500
	Preferred Accounts (500–5000 employees) Customer Care	01344 373 196
	Central Government Customer Care	01344 373 193
	Local Government & Education Customer Care	01344 373 199
	Health Customer Care	01344 373 194
	Home and Small Business Sales	0870 907 4000
	Corporate/Public Sector Sales	01344 860 456
	Website: <b>support.euro.dell.com</b>	
	Customer Care Website: <b>dell.co.uk/lca/customerservices</b>	
	E-mail: <b>dell_direct_support@dell.com</b>	

Country (City) International Access Code Country Code City Code	Department Name or Service Area, Website and E-Mail Address	Area Codes, Local Numbers, and Toll-Free Numbers
<b>U.S.A. (Austin, Texas)</b>	Automated Order-Status System	toll-free: 1-800-433-9014
International Access Code: <b>011</b>	AutoTech (For portable and desktop computers)	toll-free: 1-800-247-9362
Country Code: <b>1</b>	<b>Dell Home and Small Business Group</b> (For portable and desktop computers):	
	Customer Technical Support (Return Material Authorization Numbers)	toll-free: 1-800-624-9896
	Customer Technical Support (Home sales purchased via <a href="http://www.dell.com">www.dell.com</a> )	toll-free: 1-877-576-3355
	Customer Service (Credit Return Authorization Numbers)	toll-free: 1-800-624-9897
	<b>National Accounts</b> (Computers purchased by established Dell national accounts [have your account number handy] or value-added resellers [VARs]):	
	Customer Service and Technical Support (Return Material Authorization Numbers)	toll-free: 1-800-822-8965
	<b>Public Americas</b> (Computers purchased by governmental agencies [local, state, or federal], medical institutions, or educational institutions):	
	Customer Service and Technical Support (Return Material Authorization Numbers)	toll-free: 1-800-234-1490
	Dell Sales	toll-free: 1-800-289-3355 or toll-free: 1-800-879-3355
	Spare Parts Sales	toll-free: 1-800-357-3355
	Desktop and Portable Fee-Based Technical Support	toll-free: 1-800-433-9005
	Sales (Catalogs)	toll-free: 1-800-426-5150
	Fax	toll-free: 1-800-727-8320
	TechFax	toll-free: 1-800-950-1329
	Dell Services for the Deaf, Hard-of-Hearing, or Speech-Impaired	toll-free: 1-877-DELLTTY (1-877-335-5889)
	Switchboard	512 338-4400
	DellNet™ Technical Support	toll-free: 1-877-Dellnet (1-877-335-5638)
<b>U.S. Virgin Islands</b>	General Support	1-877-673-3355
<b>Venezuela</b>	General Support	8001-3605

## Returning Items for Warranty Repair or Credit

Prepare all items being returned, whether for repair or credit, as follows:

- 1 Call Dell to obtain an authorization number, and write it clearly and prominently on the outside of the box.
- 2 Include a copy of the invoice and a letter describing the reason for the return.
- 3 Include any accessories that belong with the item(s) being returned (power cables, CDs, guides, and so on) if the return is for credit.
- 4 Pack the equipment to be returned in the original (or equivalent) packing materials.

You are responsible for paying shipping expenses. You are also responsible for insuring any product returned, and you assume the risk of loss during shipment to Dell. Collect-on-delivery packages are not accepted.

Returns that are missing any of the preceding requirements will be refused at our receiving dock and returned to you.

## Regulatory Information

Electromagnetic Interference (EMI) is any signal or emission, radiated in free space or conducted along power or signal leads, that endangers the functioning of a radio navigation or other safety service or seriously degrades, obstructs, or repeatedly interrupts a licensed radio communications service. Radio communications services include but are not limited to AM/FM commercial broadcast, television, cellular services, radar, air-traffic control, pager, and Personal Communication Services (PCS). These licensed services, along with unintentional radiators such as digital devices, including computer systems, contribute to the electromagnetic environment.

Electromagnetic Compatibility (EMC) is the ability of items of electronic equipment to function properly together in the electronic environment. While this computer system has been designed and determined to be compliant with regulatory agency limits for EMI, there is no guarantee that interference will not occur in a particular installation. If this equipment does cause interference with radio communications services, which can be determined by turning the equipment off and on, you are encouraged to try to correct the interference by one or more of the following measures:

- Reorient the receiving antenna.
- Relocate the computer with respect to the receiver.
- Move the computer away from the receiver.
- Plug the computer into a different outlet so that the computer and the receiver are on different branch circuits.

If necessary, consult a Dell Technical Support representative or an experienced radio/television technician for additional suggestions.

Dell computer systems are designed, tested, and classified for their intended electromagnetic environment. These electromagnetic environment classifications generally refer to the following harmonized definitions:

- Class A is typically for business or industrial environments.
- Class B is typically for residential environments.

Information Technology Equipment (ITE), including peripherals, expansion cards, printers, input/output (I/O) devices, monitors, and so on, that are integrated into or connected to the system should match the electromagnetic environment classification of the computer system.

**A Notice About Shielded Signal Cables: Use only shielded cables for connecting peripherals to any Dell device to reduce the possibility of interference with radio communications services. Using shielded cables ensures that you maintain the appropriate EMC classification for the intended environment. For parallel printers, a cable is available from Dell. If you prefer, you can order a cable from Dell on the World Wide Web at [accessories.us.dell.com/sna/category.asp?category\\_id=4117](http://accessories.us.dell.com/sna/category.asp?category_id=4117).**

Most Dell computer systems are classified for Class B environments. However, the inclusion of certain options can change the rating of some configurations to Class A. To determine the electromagnetic classification for your system or device, refer to the following sections specific for each regulatory agency. Each section provides country-specific EMC/EMI or product safety information.

### **FCC Notices (U.S. Only)**

Most Dell computer systems are classified by the Federal Communications Commission (FCC) as Class B digital devices. To determine which classification applies to your computer system, examine all FCC registration labels located on the bottom or back panel of your computer, on card-mounting brackets, and on the cards themselves. If any one of the labels carries a Class A rating, your entire system is considered to be a Class A digital device. If *all* labels carry an FCC Class B rating as distinguished by either an FCC ID number or the FCC logo, (**FCC**), your system is considered to be a Class B digital device.

Once you have determined your system's FCC classification, read the appropriate FCC notice. Note that FCC regulations provide that changes or modifications not expressly approved by Dell could void your authority to operate this equipment.

This device complies with Part 15 of the FCC Rules. Operation is subject to the following two conditions:

- This device may not cause harmful interference.
- This device must accept any interference received, including interference that may cause undesired operation.

**Class A**

This equipment has been tested and found to comply with the limits for a Class A digital device pursuant to Part 15 of the FCC Rules. These limits are designed to provide reasonable protection against harmful interference when the equipment is operated in a commercial environment. This equipment generates, uses, and can radiate radio frequency energy and, if not installed and used in accordance with the manufacturer's instruction manual, may cause harmful interference with radio communications. Operation of this equipment in a residential area is likely to cause harmful interference, in which case you will be required to correct the interference at your own expense.

**Class B**

This equipment has been tested and found to comply with the limits for a Class B digital device pursuant to Part 15 of the FCC Rules. These limits are designed to provide reasonable protection against harmful interference in a residential installation. This equipment generates, uses, and can radiate radio frequency energy and, if not installed and used in accordance with the manufacturer's instruction manual, may cause interference with radio communications. However, there is no guarantee that interference will not occur in a particular installation. If this equipment does cause harmful interference to radio or television reception, which can be determined by turning the equipment off and on, you are encouraged to try to correct the interference by one or more of the following measures:

- Reorient or relocate the receiving antenna.
- Increase the separation between the equipment and the receiver.
- Connect the equipment into an outlet on a circuit different from that to which the receiver is connected.
- Consult the dealer or an experienced radio/television technician for help.

The following information is provided on the device or devices covered in this document in compliance with FCC regulations:

- Model number: MCM
- Company name:

Dell Computer Corporation  
One Dell Way  
Round Rock, Texas 78682 USA

### **NOM Information (Mexico Only)**

The following information is provided on the device(s) described in this document in compliance with the requirements of the official Mexican standards (NOM):

Exporter:	Dell Computer Corporation One Dell Way Round Rock, TX 78682
Importer:	Dell Computer de México, S.A. de C.V. Paseo de la Reforma 2620 - 11° Piso Col. Lomas Altas 11950 México, D.F.
Ship to:	Dell Computer de México, S.A. de C.V. al Cuidado de Kuehne & Nagel de México S. de R.I. Avenida Soles No. 55 Col. Peñon de los Baños 15520 México, D.F.
Model number:	MCM
Supply voltage:	115–230 VAC
Frequency:	60–50 Hz
Input current rating:	6.0/3.0 A or 4.0/2.0 A

## Limited Warranties and Return Policy

Dell-branded hardware products purchased in the U.S. or Canada come with either a one-year limited warranty, a two-year limited warranty, a three-year limited warranty, or a four-year limited warranty (U.S. only). To determine which warranty you purchased, see the Dell invoice that accompanied your computer. The following sections describe these limited warranties, the manufacturer guarantee for Latin America and the Caribbean, and the return policy for the U.S.

### One-Year Limited Warranty (U.S. Only)

Dell Computer Corporation ("Dell") manufactures its hardware products from parts and components that are new or equivalent to new in accordance with industry-standard practices. Dell warrants that the hardware products it manufactures will be free from defects in materials and workmanship. The limited warranty term is one year beginning on the date of invoice, as further described in the following text.

Damage due to shipping the products to you is covered under this limited warranty. Otherwise, this limited warranty does not cover damage due to external causes, including accident, abuse, misuse, problems with electrical power, servicing not authorized by Dell, usage not in accordance with product instructions, failure to perform required preventive maintenance, and problems caused by use of parts and components not supplied by Dell.

This limited warranty does not cover any items that are in one or more of the following categories: software; external devices (except as specifically noted); accessories or parts added to a Dell system after the system is shipped from Dell; accessories or parts added to a Dell system through Dell's system integration department; accessories or parts that are not installed in the Dell factory; or Dell Software and Peripherals products. Monitors, keyboards, and mice that are Dell-branded or that are included on Dell's standard price list are covered under this limited warranty; all other monitors, keyboards, and mice (including those sold through the Dell Software and Peripherals program) are not covered.



Dell will repair or replace products covered under this limited warranty that are returned to Dell's facility. To request warranty service, you must contact Dell's Customer Technical Support within the limited warranty period. See "Contacting Dell" on page 92 to find the appropriate contact information for obtaining customer assistance. If warranty service is required, Dell will issue a Return Material Authorization Number. You must ship the products back to Dell in their original or equivalent packaging, prepay shipping charges, and insure the shipment or accept the risk of loss or damage during shipment. Dell will ship the repaired or replacement products to you (freight prepaid) if you use an address in the continental U.S., where applicable. Shipments to other locations will be made freight collect.

Dell owns all parts removed from repaired products. Dell uses new and reconditioned parts made by various manufacturers in performing warranty repairs and building replacement products. If Dell repairs or replaces a product, its warranty term is not extended.

**THIS LIMITED WARRANTY GIVES YOU SPECIFIC LEGAL RIGHTS, AND YOU MAY ALSO HAVE OTHER RIGHTS, WHICH VARY FROM STATE TO STATE (OR JURISDICTION TO JURISDICTION). DELL'S RESPONSIBILITY FOR MALFUNCTIONS AND DEFECTS IN HARDWARE IS LIMITED TO REPAIR AND REPLACEMENT AS SET FORTH IN THIS LIMITED WARRANTY STATEMENT. ALL EXPRESS AND IMPLIED WARRANTIES FOR THE PRODUCT, INCLUDING BUT NOT LIMITED TO ANY IMPLIED WARRANTIES OF AND CONDITIONS OF MERCHANTABILITY AND FITNESS FOR A PARTICULAR PURPOSE, ARE LIMITED IN DURATION TO THE WARRANTY PERIOD SET FORTH ABOVE AND NO WARRANTIES, WHETHER EXPRESS OR IMPLIED, WILL APPLY AFTER SUCH PERIOD.**

**SOME STATES (OR JURISDICTIONS) DO NOT ALLOW LIMITATIONS ON HOW LONG AN IMPLIED WARRANTY LASTS, SO THE PRECEDING LIMITATION MAY NOT APPLY TO YOU.**

**DELL DOES NOT ACCEPT LIABILITY BEYOND THE REMEDIES SET FORTH IN THIS LIMITED WARRANTY STATEMENT OR LIABILITY FOR INCIDENTAL OR CONSEQUENTIAL DAMAGES, INCLUDING WITHOUT LIMITATION ANY LIABILITY FOR PRODUCTS NOT BEING AVAILABLE FOR USE OR FOR LOST DATA OR SOFTWARE.**

**NOTE:** Before you ship the product(s) to Dell, back up the data on the hard drive(s) and any other storage device(s) in the product(s). Remove any removable media, such as floppy disks, CDs, or PC Cards. Dell does not accept liability for lost data or software.

SOME STATES (OR JURISDICTIONS) DO NOT ALLOW THE EXCLUSION OR LIMITATION OF INCIDENTAL OR CONSEQUENTIAL DAMAGES, SO THE PRECEDING EXCLUSION OR LIMITATION MAY NOT APPLY TO YOU.

These provisions apply to Dell's one-year limited warranty only. For provisions of any service contract covering your system, refer to your invoice or the separate service contract that you will receive.

If Dell elects to exchange a product or portion of a product, the exchange will be made in accordance with Dell's Exchange Policy in effect on the date of the exchange. In any instance in which Dell issues a Return Material Authorization Number, Dell must receive the product(s) for repair prior to the expiration of the warranty period in order for the repair(s) to be covered by the limited warranty.

### **Two-Year Limited Warranty (U.S. Only)**

Dell Computer Corporation ("Dell") manufactures its hardware products from parts and components that are new or equivalent to new in accordance with industry-standard practices. Dell warrants that the hardware products it manufactures will be free from defects in materials and workmanship. The limited warranty term is two years beginning on the date of invoice, as further described in the following section.

Damage due to shipping the products to you is covered under this warranty. Otherwise, this limited warranty does not cover damage due to external causes, including accident, abuse, misuse, problems with electrical power, servicing not authorized by Dell, usage not in accordance with product instructions, failure to perform required preventive maintenance, and problems caused by use of parts and components not supplied by Dell.

This limited warranty does not cover any items that are in one or more of the following categories: software; external devices (except as specifically noted); accessories or parts added to a Dell system after the system is shipped from Dell; accessories or parts added to a Dell system through Dell's system integration department; accessories or parts that are not installed in the Dell factory; or Dell Software and Peripherals products. Monitors, keyboards, and mice that are Dell-branded or that are included on Dell's standard price list are covered under this warranty; all other monitors, keyboards, and mice (including those sold through the Dell Software and Peripherals program) are not covered. Batteries for portable computers are covered only during the initial one-year period of this limited warranty.

#### **Limited Warranty Coverage During Year One**

During the one-year period beginning on the invoice date, Dell will repair or replace products covered under this limited warranty that are returned to Dell's facility. To request warranty service, you must contact Dell's Customer Technical Support within the warranty period. See "Contacting Dell" on page 92 to find the appropriate contact information for obtaining customer assistance. If warranty service is required, Dell will issue a Return Material Authorization Number. You must ship the products back to Dell in their original or equivalent packaging, prepay shipping charges, and insure the shipment or accept the risk of loss or damage during shipment. Dell will ship the repaired or replacement products to you freight prepaid if you use an address in the continental U.S., where applicable. Shipments to other locations will be made freight collect.

Dell owns all parts removed from repaired products. Dell uses new and reconditioned parts made by various manufacturers in performing warranty repairs and building replacement products. If Dell repairs or replaces a product, its warranty term is not extended.

**NOTE:** Before you ship the product(s) to Dell, back up the data on the hard drive(s) and any other storage device(s) in the product(s). Remove any removable media, such as floppy disks, CDs, or PC Cards. Dell does not accept liability for lost data or software.

### **Limited Warranty Coverage During Year Two**

During the second year of this limited warranty, Dell will provide, on an exchange basis and subject to Dell's Exchange Policy in effect on the date of the exchange, replacement parts for the Dell hardware product(s) covered under this limited warranty when a part requires replacement. You must report each instance of hardware failure to Dell's Customer Technical Support in advance to obtain Dell's concurrence that a part should be replaced and to have Dell ship the replacement part. Dell will ship parts (freight prepaid) if you use an address in the continental U.S., where applicable. Shipments to other locations, where applicable, will be made freight collect. Dell will include a prepaid shipping container with each replacement part for your use in returning the replaced part to Dell. Replacement parts are new or reconditioned. Dell may provide replacement parts made by various manufacturers when supplying parts to you. The warranty term for a replacement part is the remainder of the limited warranty term.

You will pay Dell for replacement parts if the replaced part is not returned to Dell. The process for returning replaced parts, and your obligation to pay for replacement parts if you do not return the replaced parts to Dell, will be in accordance with Dell's Exchange Policy in effect on the date of the exchange.

You accept full responsibility for your software and data. Dell is not required to advise or remind you of appropriate backup and other procedures.

## **General Provisions**

**THIS LIMITED WARRANTY GIVES YOU SPECIFIC LEGAL RIGHTS, AND YOU MAY ALSO HAVE OTHER RIGHTS, WHICH VARY FROM STATE TO STATE (OR JURISDICTION TO JURISDICTION). DELL'S RESPONSIBILITY FOR MALFUNCTIONS AND DEFECTS IN HARDWARE IS LIMITED TO REPAIR AND REPLACEMENT AS SET FORTH IN THIS LIMITED WARRANTY STATEMENT. ALL EXPRESS AND IMPLIED WARRANTIES FOR THE PRODUCT, INCLUDING BUT NOT LIMITED TO ANY IMPLIED WARRANTIES OF AND CONDITIONS OF MERCHANTABILITY AND FITNESS FOR A PARTICULAR PURPOSE, ARE LIMITED IN DURATION TO THE WARRANTY PERIOD SET FORTH ABOVE AND NO WARRANTIES, WHETHER EXPRESS OR IMPLIED, WILL APPLY AFTER SUCH PERIOD. SOME STATES (OR JURISDICTIONS) DO NOT ALLOW LIMITATIONS ON HOW LONG AN IMPLIED WARRANTY LASTS, SO THE PRECEDING LIMITATION MAY NOT APPLY TO YOU.**

**DELL DOES NOT ACCEPT LIABILITY BEYOND THE REMEDIES SET FORTH IN THIS LIMITED WARRANTY STATEMENT OR LIABILITY FOR INCIDENTAL OR CONSEQUENTIAL DAMAGES, INCLUDING WITHOUT LIMITATION ANY LIABILITY FOR PRODUCTS NOT BEING AVAILABLE FOR USE OR FOR LOST DATA OR SOFTWARE. SOME STATES (OR JURISDICTIONS) DO NOT ALLOW THE EXCLUSION OR LIMITATION OF INCIDENTAL OR CONSEQUENTIAL DAMAGES, SO THE PRECEDING EXCLUSION OR LIMITATION MAY NOT APPLY TO YOU.**

**These provisions apply to Dell's two-year limited warranty only. For provisions of any service contract covering your system, refer to your invoice or the separate service contract that you will receive.**

**If Dell elects to exchange a system or component, the exchange will be made in accordance with Dell's Exchange Policy in effect on the date of the exchange. In any instance in which Dell issues a Return Material Authorization Number, Dell must receive the product(s) for repair prior to the expiration of the warranty period in order for the repair(s) to be covered by the limited warranty.**

### **Three-Year Limited Warranty (U.S. Only)**

Dell Computer Corporation ("Dell") manufactures its hardware products from parts and components that are new or equivalent to new in accordance with industry-standard practices. Dell warrants that the hardware products it manufactures will be free from defects in materials and workmanship. The limited warranty term is three years beginning on the date of invoice, as described in the following text.

Damage due to shipping the products to you is covered under this limited warranty. Otherwise, this limited warranty does not cover damage due to external causes, including accident, abuse, misuse, problems with electrical power, servicing not authorized by Dell, usage not in accordance with product instructions, failure to perform required preventive maintenance, and problems caused by use of parts and components not supplied by Dell.

This limited warranty does not cover any items that are in one or more of the following categories: software; external devices (except as specifically noted); accessories or parts added to a Dell system after the system is shipped from Dell; accessories or parts added to a Dell system through Dell's system integration department; accessories or parts that are not installed in the Dell factory; or Dell Software and Peripherals products. Monitors, keyboards, and mice that are Dell-branded or that are included on Dell's standard price list are covered under this limited warranty; all other monitors, keyboards, and mice (including those sold through the Dell Software and Peripherals program) are not covered. Batteries for portable computers are covered only during the initial one-year period of this limited warranty.

### Limited Warranty Coverage During Year One

During the one-year period beginning on the invoice date, Dell will repair or replace products covered under this limited warranty that are returned to Dell's facility. To request warranty service, you must contact Dell's Customer Technical Support within the warranty period. See "Contacting Dell" on page 92 to find the appropriate contact information for obtaining customer assistance. If warranty service is required, Dell will issue a Return Material Authorization Number. You must ship the products back to Dell in their original or equivalent packaging, prepay shipping charges, and insure the shipment or accept the risk of loss or damage during shipment. Dell will ship the repaired or replacement products to you freight prepaid if you use an address in the continental U.S., where applicable. Shipments to other locations will be made freight collect.

Dell owns all parts removed from repaired products. Dell uses new and reconditioned parts made by various manufacturers in performing warranty repairs and building replacement products. If Dell repairs or replaces a product, its warranty term is not extended.

### Limited Warranty Coverage During Years Two and Three

During the second and third years of this limited warranty, Dell will provide, on an exchange basis and subject to Dell's Exchange Policy in effect on the date of the exchange, replacement parts for the Dell hardware product(s) covered under this limited warranty when a part requires replacement. You must report each instance of hardware failure to Dell's Customer Technical Support in advance to obtain Dell's concurrence that a part should be replaced and to have Dell ship the replacement part. Dell will ship parts (freight prepaid) if you use an address in the continental U.S., where applicable. Shipments to other locations will be made freight collect. Dell will include a prepaid shipping container with each replacement part for your use in returning the replaced part to Dell. Replacement parts are new or reconditioned. Dell may provide replacement parts made by various manufacturers when supplying parts to you. The warranty term for a replacement part is the remainder of the limited warranty term.

**NOTE:** Before you ship the product(s) to Dell, back up the data on the hard drive(s) and any other storage device(s) in the product(s). Remove any removable media, such as floppy disks, CDs, or PC Cards. Dell does not accept liability for lost data or software.

You will pay Dell for replacement parts if the replaced part is not returned to Dell. The process for returning replaced parts, and your obligation to pay for replacement parts if you do not return the replaced parts to Dell, will be in accordance with Dell's Exchange Policy in effect on the date of the exchange.

You accept full responsibility for your software and data. Dell is not required to advise or remind you of appropriate backup and other procedures.

### **General Provisions**

THIS LIMITED WARRANTY GIVES YOU SPECIFIC LEGAL RIGHTS, AND YOU MAY ALSO HAVE OTHER RIGHTS, WHICH VARY FROM STATE TO STATE (OR JURISDICTION TO JURISDICTION). DELL'S RESPONSIBILITY FOR MALFUNCTIONS AND DEFECTS IN HARDWARE IS LIMITED TO REPAIR AND REPLACEMENT AS SET FORTH IN THIS LIMITED WARRANTY STATEMENT. ALL EXPRESS AND IMPLIED WARRANTIES FOR THE PRODUCT, INCLUDING BUT NOT LIMITED TO ANY IMPLIED WARRANTIES OF AND CONDITIONS OF MERCHANTABILITY AND FITNESS FOR A PARTICULAR PURPOSE, ARE LIMITED IN DURATION TO THE WARRANTY PERIOD SET FORTH ABOVE AND NO WARRANTIES, WHETHER EXPRESS OR IMPLIED, WILL APPLY AFTER SUCH PERIOD.

SOME STATES (OR JURISDICTIONS) DO NOT ALLOW LIMITATIONS ON HOW LONG AN IMPLIED WARRANTY LASTS, SO THE PRECEDING LIMITATION MAY NOT APPLY TO YOU.

DELL DOES NOT ACCEPT LIABILITY BEYOND THE REMEDIES SET FORTH IN THIS LIMITED WARRANTY STATEMENT OR LIABILITY FOR INCIDENTAL OR CONSEQUENTIAL DAMAGES, INCLUDING WITHOUT LIMITATION ANY LIABILITY FOR PRODUCTS NOT BEING AVAILABLE FOR USE OR FOR LOST DATA OR SOFTWARE.

SOME STATES (OR JURISDICTIONS) DO NOT ALLOW THE EXCLUSION OR LIMITATION OF INCIDENTAL OR CONSEQUENTIAL DAMAGES, SO THE PRECEDING EXCLUSION OR LIMITATION MAY NOT APPLY TO YOU.



These provisions apply to Dell's three-year limited warranty only. For provisions of any service contract covering your system, refer to your invoice or the separate service contract that you will receive.

If Dell elects to exchange a system or component, the exchange will be made in accordance with Dell's Exchange Policy in effect on the date of the exchange. In any instance in which Dell issues a Return Material Authorization Number, Dell must receive the product(s) for repair prior to the expiration of the warranty period in order for the repair(s) to be covered by the limited warranty.

### **Four-Year Limited Warranty (U.S. Only)**

Dell Computer Corporation ("Dell") manufactures its hardware products from parts and components that are new or equivalent to new in accordance with industry-standard practices. Dell warrants that the hardware products it manufactures will be free from defects in materials and workmanship. The limited warranty term is four years beginning on the date of invoice, as further described in the following text.

Damage due to shipping the products to you is covered under this limited warranty. Otherwise, this limited warranty does not cover damage due to external causes, including accident, abuse, misuse, problems with electrical power, servicing not authorized by Dell, usage not in accordance with product instructions, failure to perform required preventive maintenance, and problems caused by use of parts and components not supplied by Dell.

This limited warranty does not cover any items that are in one or more of the following categories: software; external devices (except as specifically noted); accessories or parts added to a Dell system after the system is shipped from Dell; accessories or parts added to a Dell system through Dell's system integration department; accessories or parts that are not installed in the Dell factory; or Dell Software and Peripherals products. Monitors, keyboards, and mice that are Dell-branded or that are included on Dell's standard price list are covered under this limited warranty; all other monitors, keyboards, and mice (including those sold through the Dell Software and Peripherals program) are not covered. Batteries for portable computers are covered only during the initial one-year period of this limited warranty.

**NOTE:** Before you ship the product(s) to Dell, back up the data on the hard drive(s) and any other storage device(s) in the product(s). Remove any removable media, such as floppy disks, CDs, or PC Cards. Dell does not accept liability for lost data or software.

### Limited Warranty Coverage During Year One

During the one-year period beginning on the invoice date, Dell will repair or replace products covered under this limited warranty that are returned to Dell's facility. To request limited warranty service, you must contact Dell's Customer Technical Support within the limited warranty period. See "Contacting Dell" on page 92 to find the appropriate contact information for obtaining customer assistance. If limited warranty service is required, Dell will issue a Return Material Authorization Number. You must ship the products back to Dell in their original or equivalent packaging, prepay shipping charges, and insure the shipment or accept the risk of loss or damage during shipment. Dell will ship the repaired or replacement products to you freight prepaid if you use an address in the continental U.S., where applicable. Shipments to other locations will be made freight collect.

Dell owns all parts removed from repaired products. Dell uses new and reconditioned parts made by various manufacturers in performing limited warranty repairs and building replacement products. If Dell repairs or replaces a product, its limited warranty term is not extended.

### Limited Warranty Coverage During Years Two, Three, and Four

During the second, third, and fourth years of this limited warranty, Dell will provide, on an exchange basis and subject to Dell's Exchange Policy in effect on the date of the exchange, replacement parts for the Dell hardware product(s) covered under this limited warranty when a part requires replacement. You must report each instance of hardware failure to Dell's Customer Technical Support in advance to obtain Dell's concurrence that a part should be replaced and to have Dell ship the replacement part. Dell will ship parts (freight prepaid) if you use an address in the continental U.S., where applicable. Shipments to other locations will be made freight collect. Dell will include a prepaid shipping container with each replacement part for your use in returning the replaced part to Dell. Replacement parts are new or reconditioned. Dell may provide replacement parts made by various manufacturers when supplying parts to you. The limited warranty term for a replacement part is the remainder of the limited warranty term.

You will pay Dell for replacement parts when the replaced part is not returned to Dell. The process for returning replaced parts, and your obligation to pay for replacement parts if you do not return the replaced parts to Dell, will be in accordance with Dell's Exchange Policy in effect on the date of the exchange.

You accept full responsibility for your software and data. Dell is not required to advise or remind you of appropriate backup and other procedures.

### **General Provisions**

THIS LIMITED WARRANTY GIVES YOU SPECIFIC LEGAL RIGHTS, AND YOU MAY ALSO HAVE OTHER RIGHTS, WHICH VARY FROM STATE TO STATE (OR JURISDICTION TO JURISDICTION). DELL'S RESPONSIBILITY FOR MALFUNCTIONS AND DEFECTS IN HARDWARE IS LIMITED TO REPAIR AND REPLACEMENT AS SET FORTH IN THIS LIMITED WARRANTY STATEMENT. ALL EXPRESS AND IMPLIED WARRANTIES FOR THE PRODUCT, INCLUDING BUT NOT LIMITED TO ANY IMPLIED WARRANTIES OF AND CONDITIONS OF MERCHANTABILITY AND FITNESS FOR A PARTICULAR PURPOSE, ARE LIMITED IN DURATION TO THE LIMITED WARRANTY PERIOD SET FORTH ABOVE AND NO WARRANTIES, WHETHER EXPRESS OR IMPLIED, WILL APPLY AFTER SUCH PERIOD. SOME STATES (OR JURISDICTIONS) DO NOT ALLOW LIMITATIONS ON HOW LONG AN IMPLIED WARRANTY LASTS, SO THE PRECEDING LIMITATION MAY NOT APPLY TO YOU.

DELL DOES NOT ACCEPT LIABILITY BEYOND THE REMEDIES SET FORTH IN THIS LIMITED WARRANTY STATEMENT OR LIABILITY FOR INCIDENTAL OR CONSEQUENTIAL DAMAGES, INCLUDING WITHOUT LIMITATION ANY LIABILITY FOR PRODUCTS NOT BEING AVAILABLE FOR USE OR FOR LOST DATA OR SOFTWARE. SOME STATES (OR JURISDICTIONS) DO NOT ALLOW THE EXCLUSION OR LIMITATION OF INCIDENTAL OR CONSEQUENTIAL DAMAGES, SO THE PRECEDING EXCLUSION OR LIMITATION MAY NOT APPLY TO YOU.

If Dell elects to exchange a system or component, the exchange will be made in accordance with Dell's Exchange Policy in effect on the date of the exchange. In any instance in which Dell issues a Return Material Authorization Number, Dell must receive the product(s) for repair prior to the expiration of the limited warranty period in order for the repairs to be covered by the limited warranty.

These provisions apply to Dell's four-year limited warranty only. For provisions of any on-site service contract covering your system, refer to the separate on-site service contract that you will receive.

### **One-Year Limited Warranty (Canada Only)**

Dell Computer Corporation ("Dell") manufactures its hardware products from parts and components that are new or equivalent to new in accordance with industry-standard practices. Dell warrants that the hardware products it manufactures will be free from defects in materials and workmanship. The limited warranty term is one year beginning on the date of invoice, as further described in the following text.

Damage due to shipping the products to you is covered under this limited warranty. Otherwise, this limited warranty does not cover damage due to external causes, including accident, abuse, misuse, problems with electrical power, servicing not authorized by Dell, usage not in accordance with product instructions, failure to perform required preventive maintenance, and problems caused by use of parts and components not supplied by Dell.

This limited warranty does not cover any items that are in one or more of the following categories: software; external devices (except as specifically noted); accessories or parts added to a Dell system after the system is shipped from Dell; accessories or parts added to a Dell system through Dell's system integration department; accessories or parts that are not installed in the Dell factory; or Dell Software and Peripherals products. Monitors, keyboards, and mice that are Dell-branded or that are included on Dell's standard price list are covered under this limited warranty; all other monitors, keyboards, and mice (including those sold through the Dell Software and Peripherals program) are not covered.

Dell will repair or replace products covered under this limited warranty that are returned to Dell's facility. To request warranty service, you must contact Dell's Customer Technical Support within the warranty period. See "Contacting Dell" on page 92 to find the appropriate contact information for obtaining customer assistance. If warranty service is required, Dell will issue a Return Material Authorization Number. You must ship the products back to Dell in their original or equivalent packaging, prepay shipping charges, and insure the shipment or accept the risk of loss or damage during shipment. Dell will ship the repaired or replacement products to you (freight prepaid) if you use an address in Canada, where applicable. Shipments to other locations will be made freight collect.

Dell owns all parts removed from repaired products. Dell uses new and reconditioned parts made by various manufacturers in performing warranty repairs and building replacement products. If Dell repairs or replaces a product, its warranty term is not extended.

DELL MAKES NO EXPRESS WARRANTIES OR CONDITIONS BEYOND THOSE STATED IN THIS LIMITED WARRANTY STATEMENT. DELL DISCLAIMS ALL OTHER WARRANTIES AND CONDITIONS, EXPRESS OR IMPLIED, INCLUDING WITHOUT LIMITATION IMPLIED WARRANTIES AND CONDITIONS OF MERCHANTABILITY AND FITNESS FOR A PARTICULAR PURPOSE. SOME STATES (OR JURISDICTIONS) DO NOT ALLOW LIMITATIONS ON IMPLIED WARRANTIES OR CONDITIONS, SO THIS LIMITATION MAY NOT APPLY TO YOU.

DELL'S RESPONSIBILITY FOR MALFUNCTIONS AND DEFECTS IN HARDWARE IS LIMITED TO REPAIR AND REPLACEMENT AS SET FORTH IN THIS LIMITED WARRANTY STATEMENT. THESE WARRANTIES GIVE YOU SPECIFIC LEGAL RIGHTS, AND YOU MAY ALSO HAVE OTHER RIGHTS, WHICH VARY FROM STATE TO STATE (OR JURISDICTION TO JURISDICTION).

DELL DOES NOT ACCEPT LIABILITY BEYOND THE REMEDIES SET FORTH IN THIS LIMITED WARRANTY STATEMENT OR LIABILITY FOR INCIDENTAL OR CONSEQUENTIAL DAMAGES, INCLUDING WITHOUT LIMITATION ANY LIABILITY FOR PRODUCTS NOT BEING AVAILABLE FOR USE OR FOR LOST DATA OR SOFTWARE.

**NOTE:** Before you ship the product(s) to Dell, back up the data on the hard drive(s) and any other storage device(s) in the product(s). Remove any removable media, such as floppy disks, CDs, or PC Cards. Dell does not accept liability for lost data or software.

**SOME STATES (OR JURISDICTIONS) DO NOT ALLOW THE EXCLUSION OR LIMITATION OF INCIDENTAL OR CONSEQUENTIAL DAMAGES, SO THE PRECEDING EXCLUSION OR LIMITATION MAY NOT APPLY TO YOU.**

These provisions apply to Dell's one-year limited warranty only. For provisions of any service contract covering your system, refer to your invoice or the separate service contract that you will receive.

If Dell elects to exchange a product or portion of a product, the exchange will be made in accordance with Dell's Exchange Policy in effect on the date of the exchange. In any instance in which Dell issues a Return Material Authorization Number, Dell must receive the product(s) for repair prior to the expiration of the warranty period in order for the repair(s) to be covered by the limited warranty.

### **Two-Year Limited Warranty (Canada Only)**

Dell Computer Corporation ("Dell") manufactures its hardware products from parts and components that are new or equivalent to new in accordance with industry-standard practices. Dell warrants that the hardware products it manufactures will be free from defects in materials and workmanship. The warranty term is two years beginning on the date of invoice, as described in the following text.

Damage due to shipping the products to you is covered under this limited warranty. Otherwise, this limited warranty does not cover damage due to external causes, including accident, abuse, misuse, problems with electrical power, servicing not authorized by Dell, usage not in accordance with product instructions, failure to perform required preventive maintenance, and problems caused by use of parts and components not supplied by Dell.

This limited warranty does not cover any items that are in one or more of the following categories: software; external devices (except as specifically noted); accessories or parts added to a Dell system after the system is shipped from Dell; accessories or parts added to a Dell system through Dell's system integration department; accessories or parts that are not installed in the Dell factory; or Dell Software and Peripherals products. Monitors, keyboards, and mice that are Dell-branded or that are included on Dell's standard price list are covered under this limited warranty; all other monitors, keyboards, and mice (including those sold through the Dell Software and Peripherals program) are not covered. Batteries for portable computers are covered only during the initial one-year period of this limited warranty.

### Coverage During Year One

During the one-year period beginning on the invoice date, Dell will repair or replace products covered under this limited warranty that are returned to Dell's facility. To request warranty service, you must contact Dell's Customer Technical Support within the warranty period. See "Contacting Dell" on page 92 to find the appropriate contact information for obtaining customer assistance. If warranty service is required, Dell will issue a Return Material Authorization Number. You must ship the products back to Dell in their original or equivalent packaging, prepay shipping charges, and insure the shipment or accept the risk of loss or damage during shipment. Dell will ship the repaired or replacement products to you freight prepaid if you use an address in Canada, where applicable. Shipments to other locations will be made freight collect.

Dell owns all parts removed from repaired products. Dell uses new and reconditioned parts made by various manufacturers in performing warranty repairs and building replacement products. If Dell repairs or replaces a product, its warranty term is not extended.

**NOTE:** Before you ship the product(s) to Dell, back up the data on the hard drive(s) and any other storage device(s) in the product(s). Remove any removable media, such as floppy disks, CDs, or PC Cards. Dell does not accept liability for lost data or software.

### **Coverage During Year Two**

During the second year of this limited warranty, Dell will provide, on an exchange basis and subject to Dell's Exchange Policy in effect on the date of the exchange, replacement parts for the Dell hardware product(s) covered under this limited warranty when a part requires replacement. You must report each instance of hardware failure to Dell's Customer Technical Support in advance to obtain Dell's concurrence that a part should be replaced and to have Dell ship the replacement part. Dell will ship parts (freight prepaid) if you use an address in Canada, where applicable. Shipments to other locations will be made freight collect. Dell will include a prepaid shipping container with each replacement part for your use in returning the replaced part to Dell. Replacement parts are new or reconditioned. Dell may provide replacement parts made by various manufacturers when supplying parts to you. The warranty term for a replacement part is the remainder of the limited warranty term.

You will pay Dell for replacement parts if the replaced part is not returned to Dell. The process for returning replaced parts, and your obligation to pay for replacement parts if you do not return the replaced parts to Dell, will be in accordance with Dell's Exchange Policy in effect on the date of the exchange.

You accept full responsibility for your software and data. Dell is not required to advise or remind you of appropriate backup and other procedures.

### **General Provisions**

DELL MAKES NO EXPRESS WARRANTIES OR CONDITIONS BEYOND THOSE STATED IN THIS LIMITED WARRANTY STATEMENT. DELL DISCLAIMS ALL OTHER WARRANTIES AND CONDITIONS, EXPRESS OR IMPLIED, INCLUDING WITHOUT LIMITATION IMPLIED WARRANTIES AND CONDITIONS OF MERCHANTABILITY AND FITNESS FOR A PARTICULAR PURPOSE. SOME STATES (OR JURISDICTIONS) DO NOT ALLOW LIMITATIONS ON IMPLIED WARRANTIES OR CONDITIONS, SO THIS LIMITATION MAY NOT APPLY TO YOU.



DELL'S RESPONSIBILITY FOR MALFUNCTIONS AND DEFECTS IN HARDWARE IS LIMITED TO REPAIR AND REPLACEMENT AS SET FORTH IN THIS LIMITED WARRANTY STATEMENT. THESE WARRANTIES GIVE YOU SPECIFIC LEGAL RIGHTS, AND YOU MAY ALSO HAVE OTHER RIGHTS, WHICH VARY FROM STATE TO STATE (OR JURISDICTION TO JURISDICTION).

DELL DOES NOT ACCEPT LIABILITY BEYOND THE REMEDIES SET FORTH IN THIS LIMITED WARRANTY STATEMENT OR LIABILITY FOR INCIDENTAL OR CONSEQUENTIAL DAMAGES, INCLUDING WITHOUT LIMITATION ANY LIABILITY FOR PRODUCTS NOT BEING AVAILABLE FOR USE OR FOR LOST DATA OR SOFTWARE.

SOME STATES (OR JURISDICTIONS) DO NOT ALLOW THE EXCLUSION OR LIMITATION OF INCIDENTAL OR CONSEQUENTIAL DAMAGES, SO THE PRECEDING EXCLUSION OR LIMITATION MAY NOT APPLY TO YOU.

These provisions apply to Dell's two-year limited warranty only. For provisions of any service contract covering your system, refer to your invoice or the separate service contract that you will receive.

If Dell elects to exchange a system or component, the exchange will be made in accordance with Dell's Exchange Policy in effect on the date of the exchange. In any instance in which Dell issues a Return Material Authorization Number, Dell must receive the product(s) for repair prior to the expiration of the warranty period in order for the repair(s) to be covered by the limited warranty.

### **Three-Year Limited Warranty (Canada Only)**

Dell Computer Corporation ("Dell") manufactures its hardware products from parts and components that are new or equivalent to new in accordance with industry-standard practices. Dell warrants that the hardware products it manufactures will be free from defects in materials and workmanship. The warranty term is three years beginning on the date of invoice, as described in the following text.

Damage due to shipping the products to you is covered under this limited warranty. Otherwise, this limited warranty does not cover damage due to external causes, including accident, abuse, misuse, problems with electrical power, servicing not authorized by Dell, usage not in accordance with product instructions, failure to perform required preventive maintenance, and problems caused by use of parts and components not supplied by Dell.

This limited warranty does not cover any items that are in one or more of the following categories: software; external devices (except as specifically noted); accessories or parts added to a Dell system after the system is shipped from Dell; accessories or parts added to a Dell system through Dell's system integration department; accessories or parts that are not installed in the Dell factory; or Dell Software and Peripherals products. Monitors, keyboards, and mice that are Dell-branded or that are included on Dell's standard price list are covered under this limited warranty; all other monitors, keyboards, and mice (including those sold through the Dell Software and Peripherals program) are not covered. Batteries for portable computers are covered only during the initial one-year period of this limited warranty.

### Coverage During Year One

During the one-year period beginning on the invoice date, Dell will repair or replace products covered under this limited warranty that are returned to Dell's facility. To request warranty service, you must contact Dell's Customer Technical Support within the warranty period. To request warranty service, you must contact Dell's Customer Technical Support within the warranty period. See "Contacting Dell" on page 92 to find the appropriate contact information for obtaining customer assistance. If warranty service is required, Dell will issue a Return Material Authorization Number. You must ship the products back to Dell in their original or equivalent packaging, prepay shipping charges, and insure the shipment or accept the risk of loss or damage during shipment. Dell will ship the repaired or replacement products to you freight prepaid if you use an address in Canada, where applicable. Shipments to other locations will be made freight collect.

Dell owns all parts removed from repaired products. Dell uses new and reconditioned parts made by various manufacturers in performing warranty repairs and building replacement products. If Dell repairs or replaces a product, its warranty term is not extended.

### Coverage During Years Two and Three

During the second and third years of this limited warranty, Dell will provide, on an exchange basis and subject to Dell's Exchange Policy in effect on the date of the exchange, replacement parts for the Dell hardware product(s) covered under this limited warranty when a part requires replacement. You must report each instance of hardware failure to Dell's Customer Technical Support in advance to obtain Dell's concurrence that a part should be replaced and to have Dell ship the replacement part. Dell will ship parts (freight prepaid) if you use an address in Canada, where applicable. Shipments to other locations will be made freight collect. Dell will include a prepaid shipping container with each replacement part for your use in returning the replaced part to Dell. Replacement parts are new or reconditioned. Dell may provide replacement parts made by various manufacturers when supplying parts to you. The warranty term for a replacement part is the remainder of the limited warranty term.

**NOTE:** Before you ship the product(s) to Dell, back up the data on the hard drive(s) and any other storage device(s) in the product(s). Remove any removable media, such as floppy disks, CDs, or PC Cards. Dell does not accept liability for lost data or software.

You will pay Dell for replacement parts if the replaced part is not returned to Dell. The process for returning replaced parts, and your obligation to pay for replacement parts if you do not return the replaced parts to Dell, will be in accordance with Dell's Exchange Policy in effect on the date of the exchange.

You accept full responsibility for your software and data. Dell is not required to advise or remind you of appropriate backup and other procedures.

### **General Provisions**

DELL MAKES NO EXPRESS WARRANTIES OR CONDITIONS BEYOND THOSE STATED IN THIS LIMITED WARRANTY STATEMENT. DELL DISCLAIMS ALL OTHER WARRANTIES AND CONDITIONS, EXPRESS OR IMPLIED, INCLUDING WITHOUT LIMITATION IMPLIED WARRANTIES AND CONDITIONS OF MERCHANTABILITY AND FITNESS FOR A PARTICULAR PURPOSE. SOME STATES (OR JURISDICTIONS) DO NOT ALLOW LIMITATIONS ON IMPLIED WARRANTIES OR CONDITIONS, SO THIS LIMITATION MAY NOT APPLY TO YOU.

DELL'S RESPONSIBILITY FOR MALFUNCTIONS AND DEFECTS IN HARDWARE IS LIMITED TO REPAIR AND REPLACEMENT AS SET FORTH IN THIS LIMITED WARRANTY STATEMENT. THESE WARRANTIES GIVE YOU SPECIFIC LEGAL RIGHTS, AND YOU MAY ALSO HAVE OTHER RIGHTS, WHICH VARY FROM STATE TO STATE (OR JURISDICTION TO JURISDICTION).

DELL DOES NOT ACCEPT LIABILITY BEYOND THE REMEDIES SET FORTH IN THIS LIMITED WARRANTY STATEMENT OR LIABILITY FOR INCIDENTAL OR CONSEQUENTIAL DAMAGES, INCLUDING WITHOUT LIMITATION ANY LIABILITY FOR PRODUCTS NOT BEING AVAILABLE FOR USE OR FOR LOST DATA OR SOFTWARE.

SOME STATES (OR JURISDICTIONS) DO NOT ALLOW THE EXCLUSION OR LIMITATION OF INCIDENTAL OR CONSEQUENTIAL DAMAGES, SO THE PRECEDING EXCLUSION OR LIMITATION MAY NOT APPLY TO YOU.

These provisions apply to Dell's three-year limited warranty only. For provisions of any service contract covering your system, refer to your invoice or the separate service contract that you will receive.

If Dell elects to exchange a system or component, the exchange will be made in accordance with Dell's Exchange Policy in effect on the date of the exchange. In any instance in which Dell issues a Return Material Authorization Number, Dell must receive the product(s) for repair prior to the expiration of the warranty period in order for the repair(s) to be covered by the limited warranty.

### **"Total Satisfaction" Return Policy (U.S. Only)**

If you are an end-user customer who bought new products directly from a Dell company, you may return them to Dell within 30 days of the date of invoice for a refund or credit of the product purchase price. If you are an end-user customer who bought reconditioned or refurbished products from a Dell company, you may return them to Dell within 14 days of the date of invoice for a refund or credit of the product purchase price. In either case, the refund or credit will not include any shipping and handling charges shown on your invoice. If you are an organization that bought the products under a written agreement with Dell, the agreement may contain different terms for the return of products than specified by this policy.

To return products, you must contact Dell Customer Service to receive a Credit Return Authorization Number. See "Contacting Dell" on page 92 to find the appropriate contact information for obtaining customer assistance. To expedite the processing of your refund or credit, Dell expects you to return the products to Dell in their original packaging within five days of the date that Dell issues the Credit Return Authorization Number. You must also prepay shipping charges and insure the shipment or accept the risk of loss or damage during shipment. You may return software for refund or credit only if the sealed package containing the floppy disk(s) or CD(s) is unopened. Returned products must be in as-new condition, and all of the manuals, floppy disk(s), CD(s), power cables, and other items included with a product must be returned with it. For customers who want to return, for refund or credit only, either applications software or an operating system that has been installed by Dell, the whole system must be returned, along with any media and documentation that may have been included in the original shipment.

This "Total Satisfaction" Return Policy does not apply to Dell Software and Peripherals products, which may be returned under Dell Software and Peripherals's then-current return policy.

## **One-Year End-User Manufacturer Guarantee (Latin America and the Caribbean Only)**

### **Guarantee**

Dell Computer Corporation ("Dell") warrants to the end user in accordance with the following provisions that its branded hardware products, purchased by the end user from a Dell company or an authorized Dell distributor in Latin America or the Caribbean, will be free from defects in materials, workmanship, and design affecting normal use, for a period of one year from the original purchase date. Products for which proper claims are made will, at Dell's option, be repaired or replaced at Dell's expense. Dell owns all parts removed from repaired products. Dell uses new and reconditioned parts made by various manufacturers in performing repairs and building replacement products.

### **Exclusions**

This Guarantee does not apply to defects resulting from: improper or inadequate installation, use, or maintenance; actions or modifications by unauthorized third parties or the end user; accidental or willful damage; or normal wear and tear.

### **Making a Claim**

Claims must be made in Latin America or the Caribbean by contacting the Dell point of sale within the guarantee period. The end user must always supply proof of purchase, indicating name and address of the seller, date of purchase, model and serial number, name and address of the customer, and details of symptoms and configuration at the time of malfunction, including peripherals and software used. Otherwise, Dell may refuse the guarantee claim. Upon diagnosis of a warranted defect, Dell will make arrangements and pay for ground freight and insurance to and from Dell's repair/replacement center. The end user must ensure that the defective product is available for collection properly packed in original or equally protective packaging together with the details listed above and the return number provided to the end user by Dell.

## **Limitation and Statutory Rights**

Dell makes no other warranty, guarantee or like statement other than as explicitly stated above, and this Guarantee is given in place of all other guarantees whatsoever, to the fullest extent permitted by law. In the absence of applicable legislation, this Guarantee will be the end user's sole and exclusive remedy against Dell or any of its affiliates, and neither Dell nor any of its affiliates shall be liable for loss of profit or contracts, or any other indirect or consequential loss arising from negligence, breach of contract, or howsoever.

**This Guarantee does not impair or affect mandatory statutory rights of the end user against and/or any rights resulting from other contracts concluded by the end user with Dell and/or any other seller.**

### **Dell World Trade LP**

One Dell Way, Round Rock, TX 78682, USA

**Dell Computadores do Brasil Ltda (CNPJ No. 72.381.189/0001-10)/**

**Dell Commercial do Brasil Ltda (CNPJ No. 03 405 822/0001-40)**

Avenida Industrial Belgraf, 400

92990-000 - Eldorado do Sul – RS - Brasil

### **Dell Computer de Chile Ltda**

Coyancura 2283, Piso 3- Of.302,

Providencia, Santiago - Chile

### **Dell Computer de Colombia Corporation**

Carrera 7 #115-33 Oficina 603

Bogota, Colombia

### **Dell Computer de Mexico SA de CV**

Paseo de la Reforma 2620 - 11° Piso

Col. Lomas Altas

11950 México, D.F.

11950 México, D.F.





# Index

## A

audio. *See* sound

## B

battery  
disposal, 14  
replacing, 89

BIOS, 86

## C

cards  
adding, 73  
connectors, 66  
removing, 77

CD drive  
fixing problems, 38

CD-RW drive  
fixing problems, 39

computer  
back view, 58  
crashes, 42  
error messages, 27  
front door, 58  
front view, 58  
internal parts, 65

computer (*continued*)  
removing cover, 60  
replacing cover, 80  
specifications, 82  
turning off, 20

conflicts  
resolving software and  
hardware  
incompatibilities, 47

connectors, 66

contact numbers, 92

cover  
removing, 60  
replacing, 80

crashes, 42

## D

Dell support policy, 90

display. *See* monitor

drivers  
reinstalling, 45

drives  
adding a 3.5-inch, 67  
fixing problems, 37

DVD drive  
fixing problems, 39

## E

e-mail  
fixing problems, 44

error messages  
start-up, 27  
Windows, 41

## F

Files and Settings Transfer  
Wizard, 19

finding solutions, 24

fixing problems  
drive, 37  
e-mail, 44  
general program, 42  
Internet connection, 43  
modem, 34  
mouse, 36  
network, 40  
power, 26  
printer, 32  
scanner, 34  
sound and speakers, 30  
start-up error messages, 27  
video and monitor, 28  
Windows error messages, 41

floppy drive  
fixing problems, 37

front door, 58

## H

hard drive  
fixing problems, 40

help file  
accessing, 26

## I

installing cards, 73  
installing drives, 67  
installing memory, 78

Internet  
fixing problems, 43

IRQ conflicts, 47

## K

keyboard  
fixing problems, 37

## M

memory  
adding, 78  
connectors, 66  
removing, 78

messages  
start-up, 27  
Windows, 41

modem  
fixing problems, 34

monitor  
fixing problems, 28

motherboard. *See* system  
board

mouse  
fixing problems, 36

## N

network  
fixing problems, 40  
setting up, 20

Network Setup Wizard, 20

## O

operating system  
reinstallation, 54

## P

password  
clearing system setup, 88

PCI card, 73

power  
fixing problems, 26  
turning off, 20

power supply  
rotating, 62

printer  
connecting, 16  
fixing problems, 32  
reinstalling driver, 18

printer (*continued*)  
setting up, 16  
troubleshooting, 32

programs  
fixing problems, 42

## R

RAM. *See* memory

reinstalling  
drivers, 45  
Windows 2000, 54

ResourceCD, 45

return policy, 133

## S

safety instructions, 9

ScanDisk, 40

screen. *See* monitor

settings  
system setup program, 86

shutdown, 20

software  
fixing problems, 42  
reinstalling software, 45

sound  
adjusting volume, 30  
fixing problems, 30

speaker  
adjusting volume, 30  
fixing problems, 30

specifications, 82

- system board
  - connectors, 66
- System Restore, 49, 52
- system setup program, 86

## T

- technical assistance
  - telephone numbers and addresses, 92
  - warranty repair or credit, 107
- Tell Me How help file
  - accessing, 26
- troubleshooting, 24
- turning off the computer, 20

## V

- video
  - fixing problems, 28
- volume
  - adjusting, 30

## W

- warranty information, 112
- Windows 2000
  - error messages, 41
  - Help, 26
  - printer, 32
  - reinstalling, 54
  - shutdown, 20
- Windows XP
  - device driver rollback, 46
  - error messages, 41
  - Help, 26
  - printer, 32
  - reinstalling, 52
  - shutdown, 20

